

Pearl

PEARL DRUMS 2009 PERCUSSION

GENERAL CATALOG





Dennis Chambers Independent U.S.A. Omar Hakim Independent U.S.A. Horacio Hernandez Independent U.S.A. Robby Ameen Independent U.S.A. Ricky Lawson Independent U.S.A. Will Kennedy Independent U.S.A. Terence Higgins Dirty Dozen Brass Band U.S.A.



Chad Smith Red Hot Chili Peppers U.S.A. Morgan Rose Sevendust U.S.A. Tony Palermo Papa Roach U.S.A. Eric Singer KISS, Alice Cooper U.S.A. Jimmy DeGrasso Ministry U.S.A. Tico Torres Bon Jovi U.S.A. Todd Sucherman Styx U.S.A.



Joey Jordison Slipknot U.S.A. Mike Wengren Disturbed U.S.A. Wuiv P.O.D. U.S.A. Kris Myers Umphrey's McGee U.S.A. Matt McDonough Mudvayne U.S.A. Blake Dixon Saving Abel U.S.A. Sam Loeffler Chevelle U.S.A.



Ian Paice Deep Purple UK Adrian Erlandsson Nemhain, Needleye UK Matt Tong Bloc Party UK Gareth Brown Lily Allen UK Michael "Moose" Thomas Bullet For My Valentine UK Marthus "Mart" Skaroupka Cradle of Filth UK Gary Husband Independent UK



Casey Grillo Kamelot U.S.A. Steven Sweet Warrant U.S.A. Stella Mongawa Mink U.S.A. John Longstreth Origin U.S.A. Van Williams Mink Nevermore U.S.A. David Agolia Rev Theory U.S.A. Mike Dupke WASP U.S.A.



Jonas Ekdahl EVERGREY Sweden Lionel Cordew Independent U.S.A. Raymond Bull Faber Drive U.S.A. Tyler Stewart Barenaked Ladies U.S.A. Steven Spence Black Tide U.S.A. Andy Strachan The Living End Australia Mitch Dorge Independent Canada



Daniel Erlandsson Arch Enemy Sweden Jan Axel Blomberg Dimmu Borgir, Mayhem Norway Jaska Children of Bodom Finland Juhana Karlinen Amoral Finland Jussi 69 The 69 Eyes Finland

Masking Covers

The GK-90 and BBC-1 cover the holes of BT-3 and BB-3 brackets that have been removed.



GK-90

BBC-1 for BB-3, w/Gasket, Screws and Nuts
GK-90 for BT-3, inside/outside plates w/Bolts

Stainless Steel Tension Rods

Pearl's Stainless Steel Tension Rods are machined, not forged, from a single piece of stainless steel to the most exacting tolerances in the industry. They feature super-smooth, precise tensioning, with absolutely no play. Each non-plated stainless steel tension rod is matched with a precision-machined brass swivel nut for ultra-precise performance.



SST-5028/6 M5.8 x 28mm (6)
SST-5035/6 M5.8 x 35mm (6)
SST-5038/6 M5.8 x 38mm (6)
SST-5042/6 M5.8 x 42mm (6)
SST-5047/6 M5.8 x 47mm (6)
SST-5052/6 M5.8 x 52mm (6)

Tension Rod Washers



NLW-12/12 Nylon Washers (12) White
NLW-12B/12 Nylon Washers (12) Black
MTW-12/12 Metal Washers (12)

Tension Rod LockNuts



TL-20/10 Tension Rod Lock Nuts (10/pkg)
TNK-10N/10 Tension Keeper (10/pkg)

Muffler

External clamp-on muffler for snare drums and toms. By adjusting the pressure and position of the felt pad, excessive overtones can be precisely controlled or eliminated.



OM-1 Clamp-on Muffler, Snare Drum & Toms

Hi-Hat Clutches



DCL-300P Drop Clutch, Rubber Washers, Lock Nut
SGC-300P Super Grip Clutch, Rubber Washers, Lock Nut M5.8 x 42mm (6)
CL-300 Clutch, Triple-Lock, Felt Washers, Lock Nut
CL-68N Clutch, Standard, Felt Washers

Chains & Belts



CCA-5 Chain Assy Complete for Eliminator Pedals
CCA-10 Chain Assy Complete for 1000 Series Power Shifter/PowerPro
CCA-1 Chain Assy Complete for 120 Series
BCA-1 Belt Assy Complete for Eliminator Pedals
BCA-10 Belt Assy Complete for 1000 Series

Cams, Beater Weight & Spring



EPAP-1 Package: Beater Weight, Purple Cam, Yellow Cam
CAM-PL Eliminator Purple Cam, Aggressive Action
CAM-YL Eliminator Yellow Cam, Inverse Action
CAM-BK Eliminator Black Cam, Linear Action
CAM-WT Eliminator White Cam, Oversized Linear Action
CAM-BL Eliminator Blue Cam, Progressive Action
CAM-RD Eliminator Red Cam, Radical Action
BW-100 Beater Weight, 3 Weights in One

Drum Keys



KGT-100 Gyro Tune Key w/Quick Release
K-030 Hi-Tension Tuning Key
K-050 Tuning Key

Drum Heads

Bass Drum - Front Heads w/LOGO			
Size	ProTone EBONY w/Perimeter EQ	Size	ProTone COATED w/Perimeter EQ
18"	PTH-18PL	18"	PTH-18CEQPL
20"	PTH-20PL	20"	PTH-20CEQPL
22"	PTH-22PL	22"	PTH-22CEQPL
24"	PTH-24PL	24"	PTH-24CEQPL

Pro Tone Tom Heads			
Size	COATED-Single Ply	CLEAR-Single Ply	CLEAR-2Ply
8"	PTH-08C	PTH-08	PTH-08D
10"	PTH-10C	PTH-10	PTH-10D
12"	PTH-12C	PTH-12	PTH-12D
13"	PTH-13C	PTH-13	PTH-13D
14"	PTH-14C	PTH-14	PTH-14D
15"	PTH-15C	PTH-15	PTH-15D
16"	PTH-16C	PTH-16	PTH-16D
18"	PTH-18C	PTH-18	PTH-18D

Practice Pads

Silencer Rubber Pads



RP-50
Our RP-50 features five rubber discs for silent practicing on drumsets with 12", 13", and 16" toms, and 14" snare drum. A universal-fit bass pad with adjustable straps is also included. They remove easily for resumption of live play.

RP-40C
Our RP-40C Cymbal Silencers effectively reduce the volume of cymbals for practicing. The set includes an 18"/20" cymbal pad, 14"/16" cymbal pad, and a pair for 14" hi-hats.

Bass Drum Pedal Training Pads

BD-10
The BD-10 bass pad is perfect for practicing at home or on the road. The wide pad accommodates double pedals and is specially formulated for extremely low noise and a realistic feel. The universal-fit "hoop" accepts all brands of pedals and adjusts to compensate for different floor surfaces. The BD-10 folds for compact transport.



Training Drum Pads

SD-50
The SD-50 features Pearl's unique rubber pad surface with realistic rebound and near silent performance. The stand and pad use heavy-duty 8mm threading for superior durability and stability.



Bass Drum - Batter Heads			
Size	ProTone CLEAR w/Perimeter EQ	ProTone COATED w/Perimeter EQ	ProTone CLEAR Double Ply
18"	PTH-18EQ	PTH-18CEQ	---
20"	PTH-20EQ	PTH-20CEQ	PTH-20D
22"	PTH-22EQ	PTH-22CEQ	PTH-22D
24"	PTH-24EQ	PTH-24CEQ	PTH-24D

Muffle Heads			
Size	Model #	Size	Model #
8"	MFH-08	14"	MFH-14
10"	MFH-10	16"	MFH-16
12"	MFH-12	20"	MFH-20B
13"	MFH-13	22"	MFH-22B

Snare Drum Heads	
Size	SNARE SIDE
13"	SS-13S
14"	SS-14S



Pearl Drums 2009 Color Line Up

REFERENCE RF

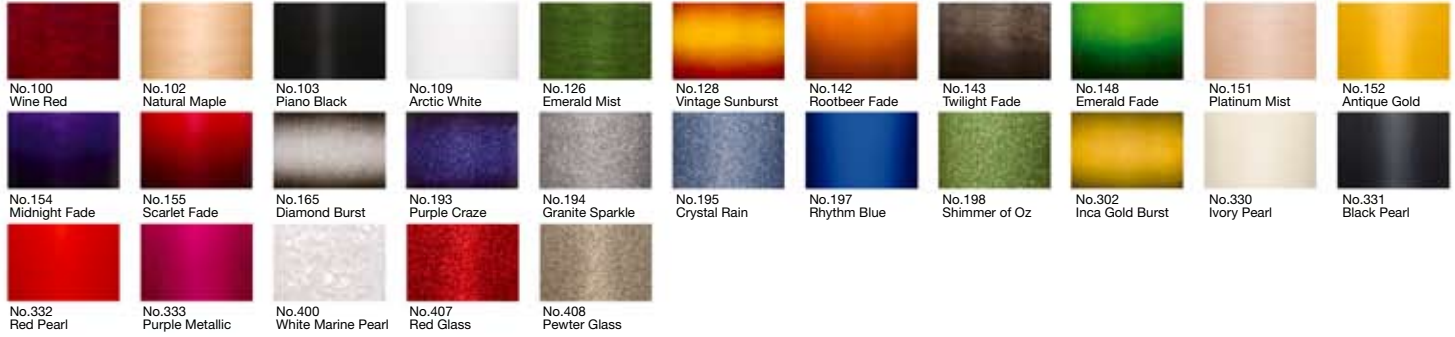

MASTERS PREMIUM MMP/MRP



MASTERS PREMIUM BMP/BRP



MASTERS MCX



VISION VMX



VISION VBX



VISION VSX



VISION VX



FORUM FZ



PEARL DRUMS and PEARL PERCUSSION GENERAL CATALOG 2009 VOLUME.001

For more information on these or any Pearl product, visit your local authorized Pearl Dealer. You can also visit us on the World Wide Web Site

Colors shown in this catalog are for representation only and may not be exactly the same as the original colors due to the printing processes involved. Products and specifications are subject to change without notice.

www.pearldrums.com

Printed in USA ITEM #PGC309



Mike Mangini
Independent
U.S.A.



Shane Gaalaas
B'z/Cosmosquad
U.S.A.



Virgil Donati
Planet X, Virgil Donati Band
U.S.A.



Jessie Caraballo
Marc Anthony
U.S.A.



Steve Houghton
Independent
U.S.A.



Billy Hart
Independent
U.S.A.



Kenwood Dennard
Just Advance
U.S.A.



Ben Smith
Heart
U.S.A.



Rich Beddoe
Finger Eleven
U.S.A.



Dave DiCenso
Independent
U.S.A.



Rodney Howard
Gavin DeGraw/Avril Lavigne
U.S.A.



Michael Cartellone
Lynyrd Skynyrd
U.S.A.



Stanley Randolph
Stevie Wonder
U.S.A.



Michael Butler
Akon
U.S.A.



Johnny Kelly
Type O Negative
U.S.A.



Craig Nunenmacher
Black Label Society
U.S.A.



Criz
Lacuna Coil
Italy



Barry Kerch
Shinedown
U.S.A.



Gene Hoglan
DETHKLOCK
U.S.A.



Brian Young
Fountains of Wayne
U.S.A.



Gene Jackson
Independent
U.S.A.



Ray Fean
Celtic Woman
Ireland



Flo Mounier
Cryptopsy
Canada



Nate Morton
Cher/Bonnie Hunt Show
U.S.A.



Matt Marquez
Haste The Day
U.S.A.



Ryan Richards
Funeral for a Friend
UK



Cody Hanson
Hinder
U.S.A.



Matt Abts
Gov't Mule
U.S.A.



Sean Rickman
Garaj Mahal
U.S.A.



Steve Gillis
Independent
U.S.A.



Jack Irons
Independent
U.S.A.



Jonathan Mover
Independent
U.S.A.



Chad Gracey
Live
U.S.A.



Yonrico Scott
Derek Trucks Band
U.S.A.



Clarence Penn
Makoto Ozone
U.S.A.



Tommy Campbell
Independent
U.S.A.



Dani Löble
Helloween
Germany



Iggor Cavalera
Cavalera Conspiracy
Brazil



Rudy Sanchez
Independent
Mexico



Aaron Gainer
12 Stones
U.S.A.



Jon Farriss
INXS
Australia



Torry Castellano
The Donnas
U.S.A.



Grant Collins
Independent
Australia



Michael Barker
The John Butler Trio
Australia



Patrick Johansson
Yngwie Malmsteen
U.S.A.



Steve Bolognese
Into Eternity
U.S.A.



Glen Crain
Hollywood Undead
U.S.A.

Chad Smith
Red Hot Chili Peppers



Extreme Strength | Optimal Resonance | Superior Tone

Pearl's Superior Shell Technology utilizes a proprietary technique for achieving the ultimate air chamber. It begins with select woods chosen for their unique acoustic attributes, milled to precise thickness with overlapping scarf joint seams for a perfect air-tight fit. The wood plies are saturated with Pearl's proprietary "AcoustiGlue" that permeates every pore and dries to the exact consistency of the wood for optimum resonance. Finally the plies are formed in high-temperature molds with 1000 PSI of hydraulic pressure to produce perfect drum shells that exhibit superior tone, optimal resonance and extreme strength.

Scarf Joints

Our Scarf Joint seams provide 800% greater surface area than conventional butt joints. This provides extreme strength and integrity to the shell while simultaneously eliminating air pockets that can disrupt vibration, so the shells vibrate uniformly for superior resonance. Other companies use butt joints where the seams are simply butted together. A butt joint works if the ends meet exactly, but often they don't and a gap is formed. Within the gap is air which is an excellent insulator. Air stops sound. For example, recording studios are built with a room within a room with air separating the two to stop sound from interfering with recordings. This is great for studios but not for drums. As drummers we want drums to vibrate freely and evenly without air pockets to impede vibration. With S.S.T., our use of scarf joints ensures no gaps and no air pockets, so the shells vibrate fully and uniformly for superior resonance.

Proprietary "AcoustiGlue"

"AcoustiGlue" is Pearl's special proprietary adhesive that hardens within the shell to the same density as the wood it binds, thus allowing the shells to respond as if they were made from a single-ply of wood. During shell formation the hydraulic mold is heated and the glue is liter-

ally boiled into the pores of the wood to ensure complete adhesion. Simultaneously, 1000 PSI is applied for thorough bonding of the plies to create the finest drum shell in the world. No other system uses this perfect combination of heat and pressure to ensure a perfect drum shell with extreme strength and tonal character. Now we have a perfect, gapless air chamber. The shell is then trimmed and the ends squared to assure overall tuning consistency and head seal.



Bearing Edges

This critical step is another key component in the quality of our shells. Our standard edges feature a 45° angled bearing edge on the inner diameter with 45° backcut over the second ply from the outside of the shell for a highly focused contact point, providing outstanding balance between attack and resonance. Our Reference drums feature rounded 45° edges on 8" to 13" toms and fully rounded edges on drums 14" and larger for more head-to-shell contact area for maximum shell vibration and resonance.

A Brilliant Finish

Finally Pearl's signature finish is applied to the drum. Pearl's painting process matches beauty with durability. Whether it's a custom Masterworks finish, designed to your exact specifications, or the 31-step super high gloss finishes found on Reference and Masters Premium - your drums will look as good as they sound for years to come.

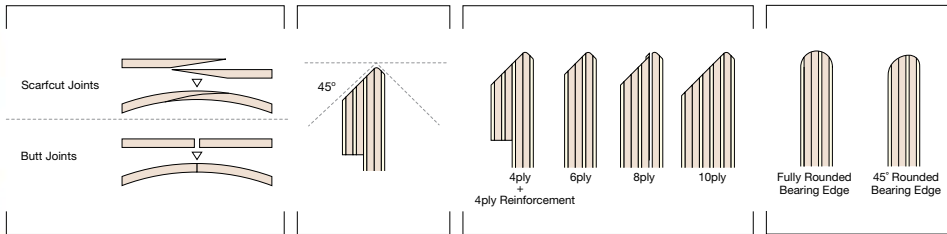

**"Hard Work and Passion...
A Little Luck... 20 Years
Together and The greatest
drums on the planet.
Me and Pearl. "**

Pearl's Superior Shell Technology Assures Manufacturing Excellence. Every Time.



No inferior butt seams here. These tapered scarf joints seamlessly overlap for perfect shell resonance and consistency. Our proprietary "AcoustiGlue" permeates the wood and hardens to the same consistency as the wood. The scarf joints are carefully staggered upon insertion of the specially designed mold. Extreme heat and over 1000 PSI pressure are simultaneously applied to the shell during formation. A perfect, gapless air chamber. The shell is then trimmed and the ends squared to assure overall tuning consistency and head seal. Our exclusive bearing edge incorporates a 45° out and 45° in, slightly rised from the exterior, to optimize contact with the flat portion of the drum head. Pearl's finishes are the industry state-of-the-art. Your choice of finish is encased in layers of highly durable urethane and polished to a high luster. Truly a work of art.



Omar Hakim
Studio Legend

"What's really great about Pearl is that they make all their drumsets. They don't outsource to another company. Every series is manufactured by the skilled professionals at Pearl Drums."

Pearl's Innovative Features

Lug Design

Bridge style lugs and floor tom brackets provide maximum resonance with minimal shell contact. Pearl's revolutionary BRL lugs assure the ultimate in head seating and tuning integrity. The unique swivel function allows the tension rods to align perfectly into the lugs so there's no lateral pressure against the hoops, thus assuring maximum resonance and sustain.

**Floor Tom Leg Brackets
Air Suspension Rubber Tips**

Full height adjustment with our built in memory lock keeps floor tom positioning perfectly set. Our patented Air Suspension Rubber Tip allows your floor tom to rest on a cushion of air. These large rubber feet prevents premature sound decay from floor contact. Floor toms never has it so good.

OptiMount Suspension System

The OptiMount Suspension System provides tom mounting with zero shell contact for ultimate resonance. By attaching to the tension bolts via isolated rubber bushings the shell is allow to float which in turn allows it to sing to its fullest capabilities.

MasterCast Die-Cast Hoop

Our die cast hoops offer state-of-the-art head seating and tuning capabilities thanks to their structural strength and precision manufacturing technique. The MasterCast

Hoop system prevents binding and allows the shell to resonate to its absolute fullest potential.

Bass Drum Claw Hook

Our bass drum claws incorporate rubber hoop isolators for scratch prevention on lacquered hoops, provide evenly distributed clamping force for consistent tuning. The key bolts are recessed for snag-free fit in carrying cases and to eliminate accidental detuning.

Bass Drum Spur

Our telescoping spurs feature rubber or spike tips for maximum traction control. The high-grip rubber tip can be retracted to allow a recessed spike to be exposed for maximum "bite" on carpeted surfaces.

Stainless Steel Tension Bolts

Pearl's stainless steel tension rods are machined from a single piece of stainless steel to the most exacting tolerances in the industry. They feature super smooth and precise tensioning with absolutely no play. Each is matched with a precision-machined brass swivel nut for ultra-precise performance.



The Golden Ratio, also known as the Golden Section, Golden Mean, Golden Rectangle, and the Divine Proportion, has fascinated mathematicians since the time of the Pharaohs. It is a mathematical constant (1.61803) that is found repeatedly in nature and has been used by artisans for generations to create art and structures with pleasing proportions. Stradivarius applied the Golden Ratio to define the location of the "f-holes" and proportions of his masterwork violins. The exterior dimensions of the Parthenon are said to form a perfect Golden Rectangle. The proportions found in Leonardo da Vinci's "Last Supper" follow the Golden Ratio. Intrigued by this, our engineers asked if the Golden Ratio was applicable to drums



and more specifically to the location of the air vents. For every drum depth there's an upper and lower Golden Ratio location, and testing revealed that the upper location noticeably improves attack, which is perfect for snare drums, while the lower position improves low frequency response, which is ideal for toms and bass drums. Pearl's revolutionary new Golden Ratio air vents are so unique they're patent pending. Experience the sound of Golden Ratio air vents, centuries in the making, exclusively on Masterworks and Masters Premium, exclusively from Pearl.



Completely Custom, Totally Handmade, Pearl Drums

With no assembly line boundaries and no mass production compromises,
Masterworks drums truly represent all that is possible.

Each drum is a work of art, constructed by seamlessly blending the artisan qualities and wisdom of hand craftsmanship,
with the technology and precision of state of the art custom built machinery. There is no inventory.

Every drum in your kit is designed by you, and hand built to your exacting specifications, one drum at a time.

We've assembled an elite group of Pearl master craftsmen in order to manufacture the finest drums the world has ever known.

Masterworks drums are as individual as you are, and like no other you have heard or seen before.



Drummer's Dream Come True

Pearl's Masterworks Series represents the fruition of over 60 years of acoustic drum research and craftsmanship. When you choose Masterworks, you're selecting drums that epitomize exactly what you want in a set of drums. Why? Because you design them. From shell thickness and composition to exterior finish and hardware plating, Masterworks is the only completely custom drumset available. There's no inventory, no pre-fabricated shells sitting on a shelf. Every drum in your kit is designed by you and built to the most exacting tolerances by the world's finest master craftsmen using the industry's most advanced custom-built machinery. Completely custom. Totally handmade. It's a musician's dream come true. Whatever your musical style, Masterworks can build a kit to express every nuance of your individual style. With Masterworks, it's about choices. The choices begin with the selection of the

shell material that precisely suits your playing style. Maple is an excellent choice for general purpose applications due to its smooth, warm, well rounded tone, with equal amounts of hi-end attack and mid-range body, and an excellent low-end punch. Birch is known for its "naturally EQ'ed sound" that offers slightly boosted hi-end frequencies, a smooth, mellow mid-range and a deep low-end presence and is a great choice for any applications that requires extra presence and cut. African mahogany is the ideal choice when maximum warmth and low frequencies are a priority.



Shell Thickness Options

With Masterworks you can choose the thickness of your shells to precisely tailor the sound to your exact needs. Thin shell drums offer great resonance and maximum tone that can be most appreciated in near-field applications. Thick shells are extremely "efficient" and provide ultimate volume and projection. These drums are ideal for any application requiring high sound pressure levels with maximum cut. Medium thickness shells offer a very good compromise between volume and resonance and are ideal for general purpose applications. With Masterworks, each drum can be crafted with a different thickness to precisely achieve the sound you want...the choice is yours.



Thin shells drums offer great resonance and maximum tone that can be most appreciated in near-field situations.

Thin

Thin shell drums have become extremely popular in recent years as their sound offers the best "near field" or player's experience. Our 4 ply, 5mm shell enables relatively easy energy transfer from the heads to the shell, thus causing the shells to fully vibrate. This vibration imparts a very rich, warm "wood" tone to the overall sound that can be most appreciated close to the kit while it's played. This effect is also great for recording where miking techniques can capitalize on the warmth and natural tone of the instrument. Most manufacturers offer a thin shell hi-end drum series, and Pearl's Masters Premium MMP/BMP Series drums are a perfect representation. Our 4 ply, 5mm shell also features an extra 4 ply, 5mm reinforcement ring at both top and bottom to help strengthen the shell and add support at critical head contact points for stability.



Choosing the Wood for the Shell



Maple

Maple has been a favorite choice of drum manufacturers since the late 1700's. Its grain is a beautiful canvas for transparent finishing techniques and its tone is ideal for general purpose, all encompassing applications. Our North American Maple, like all of the woods used for Masterworks drums, is hand-selected to meet stringent requirements for proper density, age, and consistency of grain and color. Maple offers

a smooth, warm, well rounded tone, with equal amounts of hi-end attack and mid-range body, and an excellent low-end punch. Most drum manufacturers offer some form of 100% Maple drum today as it has become the standard of the industry for high end drum sets.



Birch

Birch drums have gained an almost cult following over the years which started around the 1970's. Their "naturally EQ'ed sound" offers the perfect alternative to the overall smoothness of Maple. Many professional players today prefer the sound of Birch to any other material in use for the manufacture of drums. Our prime Scandinavian Birch offers a slightly boosted hi-end cut, a smooth, mellow mid range and a deep low end presence. Many popular Birch shell

drums have found their way to recording studios where they are a favorite of both the player and engineer. Their sound translates equally for both live and recorded situations as Birch drums are a great choice for any application that requires extra presence and cut.



African Mahogany

Mahogany was the industry standard for drum shell manufacture for over fifty years and one listen will tell you why. Our supreme quality African Mahogany is extremely rich in low-end frequencies, with beautifully smooth mids and a slight roll-off in the higher register. Drums made from African Mahogany have warmth and body that sets them apart from all others. Few companies today offer this excellent wood for drum shells

simply because its porous exterior is extremely difficult to finish and it costs more than Maple. Without question, if your main requirements are "bottom" and punch, African Mahogany should be your wood of choice.

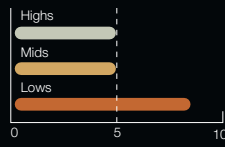

Features slightly boosted lows with smooth mid and high frequencies. Ideal for all around applications.



Composite Shell

The beauty of Masterworks is the ability to custom configure a kit down to the wood plies used for the shells. A composite shell, featuring more than one wood, is a great way to blend the characteristics offered by different materials. For instance, you may choose outer plies of Maple or Birch for their ease of finishing, beautiful grain and sound characteristics, and inner plies of African Mahogany to boost bass and low end punch. While

this is a very popular Masterworks composite, remember there is no wrong way to configure your shell and each drum in your kit can be different if you so choose. The only requirement is that plies must be specified in groups of 2, as in 2 outer plies of Maple plus 2 inner plies of African Mahogany, for a 4 ply shell.



Carbon Ply

If you desire something more futuristic, we offer the cutting edge of drums with Carbon Fiber. This ultra exotic hybrid features 6 plies of 5.4mm Maple sandwiched between an inner and outer ply of Carbon Fiber. These drums produce a sound that goes beyond description and must be experienced.

Medium

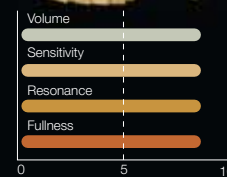

Medium thickness shells are ideal for general purpose applications and/or situations requiring more "horsepower." They offer a very good compromise between volume and resonance.



Medium thickness drums, as with our 6 ply, 7.5mm Masters MCX shells, have slightly greater stiffness and resist some of the energy transfer from the heads. With slightly less vibration, a trade-off is achieved allowing the sound to be slightly "cooler" than a thin shell drum, but with greater volume and projection. These drums represent a great choice for all around, general purpose applications, offering a warm, full bodied wood tone, with great attack, loudness and presence. Medium thickness shells may offer the best of both worlds providing the perfect compromise between resonance and volume.



Thick shells are extremely "efficient" and provide ultimate volume and projection. These drums are ideal for any application requiring high sound pressure levels with maximum cut.

Thick

Thicker shell drums are extremely "efficient" and allow most of the player's energy to be focused through the heads directly to the audience. Since the shell provides greater mass, less volume is lost through the shell in the form of resonance. They offer good tone and warmth but at reduced levels compared to their thinner shell counterparts. These drums are ideal for coliseum-type venues and other applications requiring high sound pressure levels and ultimate volume. Masterworks drums are available in both an 8 ply, 10mm thickness and a 10 ply, 12.5mm thickness. Snare drums made in these thicknesses rival metal snare drums in intensity and projection, providing a great cannon-like crack with extreme volume.

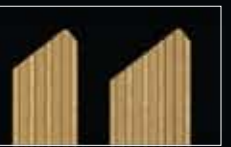

Artisan Finishes

Complete your Masterworks masterpiece with your choice of our peerless Masterworks Artisan finishes or stunning super high gloss lacquer finishes. Artisan exotic wood veneers offer gorgeous one-of-a-kind looks to set your kit apart from all others.

Highly figured woods are available including Bubinga, Tamo, Eucalyptus, Flame Maple



and Burl Mahogany. Our super high gloss lacquer finishes are hand-applied over a week's time with multiple coats for a "mile-deep" look that you'll treasure and others will envy.

Bearing Edge Options

Other than the shell material, nothing influences your drum's overall response and tonal spectrum more than the bearing edge. That's why Masterworks gives you three bearing edges from which to choose from.



45 Degrees
Pearl's legendary 45 degree bearing edge delivers the perfect blend of attack and warmth.



Rounded 45
The rounded 45 bearing edge provides maximum head-to-shell contact as a result of greater head-to-shell contact.



Fully Rounded
The fully rounded bearing edge provides maximum head-to-shell contact for a greatest boost in mid to low range frequencies.

Hardware Color

All Masterworks Series drums are available in your choice of Chrome, Gold, or Black Chrome plated drum hardware finishes to make your kit as unique as you are.



Chrome Gold Black Chrome

MasterWorks

Masterworks



Todd Sucherman
Styx

"Being able to design your own drums in the Masterworks line is truly a dream come true."



Masterworks Black Cherry

Bass Drum : MW2218B Tom Tom : MW0807T , MW1008T, MW1209T Floor Tom : MW1515F Snare Drum : MW1450S
Hardware & Accessories : H-2000, S-2000, P-2000C, BC-2000 (x2), TC-2000



Masterworks Tint Blue

Bass Drum : MWA2218B Tom Tom : MWA1008T, MWA1209T Floor Tom : MWA1414F, MWA1616F Snare Drum : MWA1465S
Hardware & Accessories : S-2000, P-2002C, T-2000, PS-85, BC-2000 (x5), H-2000



Joey Jordison
Slipknot

"I have never played better than on a kit from Pearl. Never!"



Reference

A Complete Set Of Individually Engineered, Incredible Sounding Drums

The Reference Mission

To fully understand these drums you must accept that the desired tonal characteristics of a rack tom are completely different than that of a bass drum, and to make these drums with the same composition would result in a compromise. This is the mission behind Reference Series: To create a perfect sounding drum set where every drum is optimally engineered to produce the best sound possible within its respective tonal range and diameter...drum by drum by drum. Forget what you think you know about drums and take a closer look at Pearl's Reference Recipe and the synergy of its three task-specific components.

Reference **Recipe**

Optimized Shell Composition

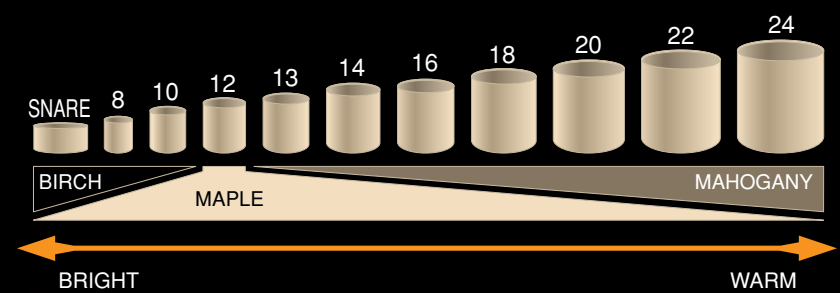

Optimized Bearing Edge

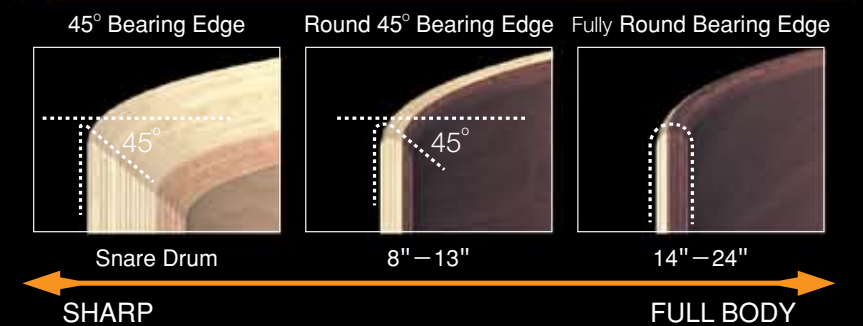

Optimized Thickness

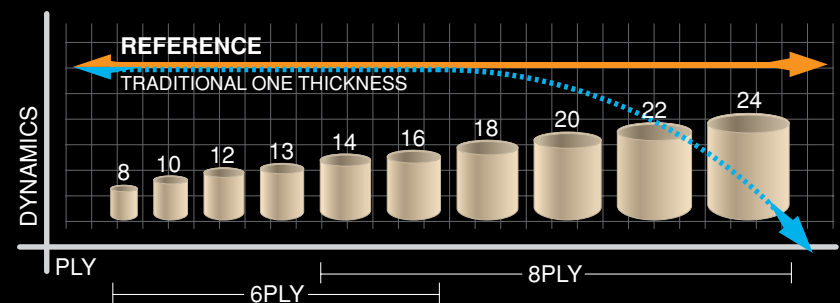

With Reference Series, it's not about compromise, it's about every drum in your kit performing at its optimal capacity.

Reference



Dennis Chambers
Studio Legend

"Pearl Drums Sound Great. Feel Great. And Look Great.
That's All That Matters."



Reference No.193 Purple Craze

Bass Drum : RF2218BX/C Tom Tom : RF0808T/C, RF1008T/C, RF1209T/C Floor Tom : RF1414F/C, RF1616F/C Snare Drum : RF1465S/C, M1040
Hardware & Accessories : H-2000, S-2000(x2), P-2000C(x2), T-2000, TC-2000, BC-2000(x2), B-1000(x3), TL-2000(x3), HH-3, HH-4, PBL-10, PBL-30, PPS-20



Reference No.400 White Marine Pearl

Bass Drum : RF2218BX/B Tom Tom : RF1208T/B Floor Tom : RF1414F/B, RF1616F/B Snare Drum : RF1465S/B
Hardware & Accessories : H-2000, S-2000, P-2000C, TC-2000, B-1000 (2X), C-1000 (3X)



Eric Singer
KISS/Alice Cooper

"I have played Pearl Drums for over 22 years
and have never even thought about using
anything else."

Reference



Reference No. 198 Shimmer of Oz

Bass Drum : RF2220BX/C **Tom Tom :** RF1008T/C, RF1209T/C **Floor Tom :** RF1414F/C, RF1616F/C **Snare Drum :** RF1450S/C,
Hardware & Accessories : H-1000K, S-2000, P-2002C, TC-2000 (x2), BC-2000, C-1000

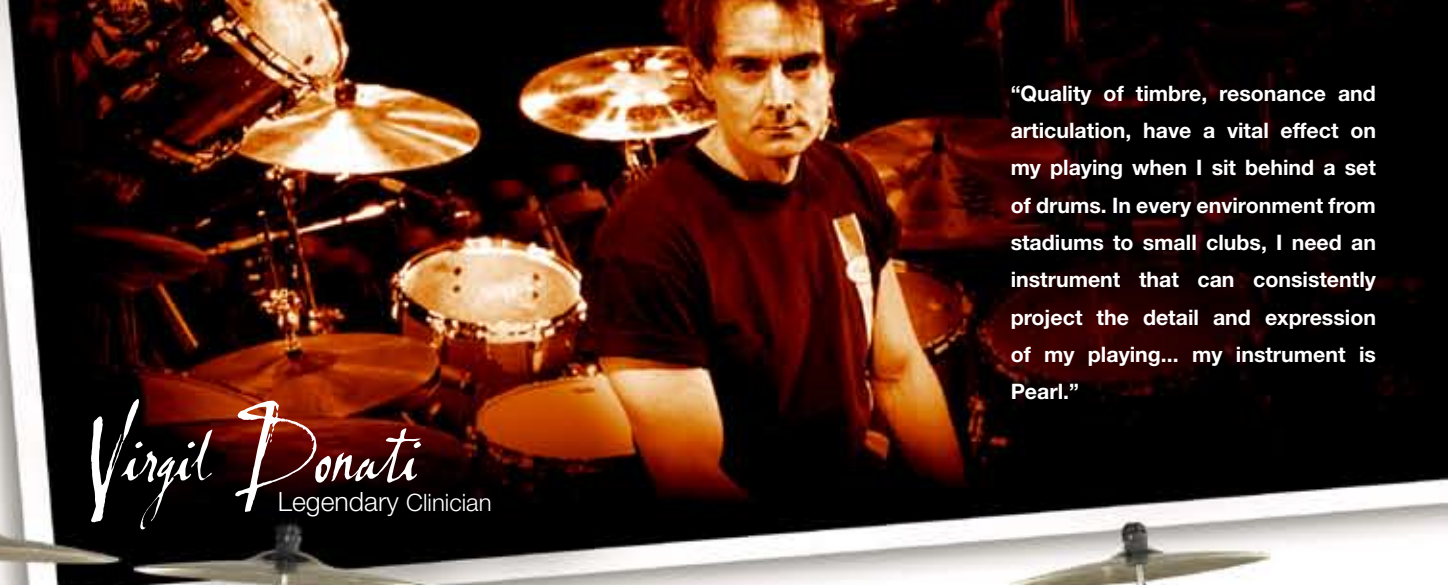

Virgil Donati
 Legendary Clinician

"Quality of timbre, resonance and articulation, have a vital effect on my playing when I sit behind a set of drums. In every environment from stadiums to small clubs, I need an instrument that can consistently project the detail and expression of my playing... my instrument is Pearl."



Reference No. 330 Ivory Pearl

Bass Drum : RF2418BX/C **Tom Tom :** RF1310T/C, **Floor Tom :** RF1414F/C, RF1616F/C RF1816F/C **Snare Drum :** RF1450S/C
Hardware & Accessories : H-2000, S-2000(2x), P-2000C, BC-2000(x4), D-2000

Horacio "el negro" Hernandez

Studio Legend



"My 11 year affair with Pearl has given me the best instruments by the best team in the industry."

Reference Specifications

- * Pearl's exclusive SST Superior Shell Technology
- * Light Weight Aluminum OptiMount Suspension System
- * BRL Bridge Lugs w/Swivel Function
- * LB-200 Bridge Type Floor Tom Leg Brackets
- * LG-200 Floor Tom Legs
- * SP-300 Spurs
- * MasterCast Die-Cast Hoops(toms, floor toms)
- * Stainless Steel Tension Rods
- * Remo Clear Emperor Batter Heads
- * Remo Clear Powerstroke3 Bass Drum Batter Head
- * Remo "Window" Snare Batter Head



Hardware Color

All Reference drums are available in your choice of Chrome, Gold, or Black Chrome plated drum hardware.



Shell Composition

	8" & 10" 6 ply Maple 4 Birch 2
	12" 6 ply Maple 6
	13"-15" 6 ply Maple 4 Mahogany 2
	16" 6 ply Maple 2 Mahogany 4

	14" & 15" 8 ply Maple 4 Mahogany 4
	16" & 18" 8 ply Maple 2 Mahogany 6
	18" & 20" 6 ply Maple 2 Mahogany 4
	22" & 24" 8 ply Maple 2 Mahogany 6

Reference Model Numbers

Specification Chart	Tom Tom
Bass Drum	8" x 7" RF0807T/C
24" x 18" RF2418BX/C (BB/C)	8" x 8" RF0808T/C
24" x 16" RF2416BX/C (BB/C)	10" x 8" RF1008T/C
22" x 20" RF2220BX/C (BB/C)	10" x 9" RF1009T/C
22" x 18" RF2218BX/C (BB/C)	10" x 10" RF1010T/C
22" x 16" RF2216BX/C (BB/C)	12" x 8" RF1208T/C
20" x 18" RF2018BX/C (BB/C)	12" x 9" RF1209T/C
20" x 16" RF2016BX/C (BB/C)	12" x 10" RF1210T/C
20" x 14" RF2014G/C (w/BF-3 x 2)	13" x 9" RF1309T/C
18" x 16" RF1816BX/C (BB/C)	13" x 10" RF1310T/C
18" x 14" RF1814BX/C (BB/C)	13" x 11" RF1311T/C
	14" x 10" RF1410T/C
	14" x 11" RF1411T/C
Floor Tom	14" x 12" RF1412T/C
16" x 16" RF1616F/C	15" x 13" RF1513T/C
18" x 16" RF1816F/C	15" x 14" RF1514T/C
	16" x 13" RF1613T/C
	16" x 14" RF1614T/C



Masters
PREMIUM

The Legendary Sound of Pearl

Masters Premium

For more than two decades, the legendary Pearl Masters sound has been heard on countless recordings and in the world's top recording studios. The Masters sound is synonymous with legendary drummers like Jeff Porcaro, Dennis Chambers and many others. The Pearl Masters Premium Series offers the discerning player precision, beauty, innovation and options. This special order series is available in your choice of 4 ply or 6 ply 100% Maple or 100% Birch shells, and features upgraded lowmass aluminum OptiMounts, Masterworks/Reference bass drum spurs, bass drum claws, floor tom legs and leg brackets. Masters Premium snare drums feature Pearl's premium swivel tube lugs that assure perfect tension rod to lug alignment. All Masters Premium drums feature Pearl's innovative Golden Ratio air vents for improved low end response on toms and bass drums and improved attack on snare drums. You can choose from a total of 34 finishes including 26 super high gloss lacquer finishes and 8 premium coverings. All shells are constructed using Pearl's exclusive SST Superior Shell Technology manufacturing process.

Masters Premium MMP / BMP 4ply

Pearl's 4 ply shells with 4 ply reinforcement hoops produce a "vintage" sound with deep, rich tone and incredible sensitivity.



MMP
4ply [Maple]
with 4ply Reinforcement Rings

BMP
4ply [Birch]
with 4ply Reinforcement Rings

Masters Premium MRP / BRP 6ply

Our classic 6 ply shells have more attack and power for outstanding presence on stage and in the studio.



MRP
6ply [Maple]

BRP
6ply [Birch]



Masters Premium



Ricky Lawson
Studio Legend

"The best only ask for the best.
Pearl drums, for the perfect performance everytime."



Masters Premium MMP No.333 Purple Metallic

Bass Drum : MMP2016BX/C Tom Tom : MMP1008T/C, MMP1209T/C Floor Tom : MMP1616F/C Snare Drum : MMP1465S/C
Hardware & Accessories : H-2000, S-2000, P-2000C, TC-2000(x2), B-1000, C-1000

Masters Premium MRP No.331 Black Pearl

Bass Drum : MRP1814BB/C Tom Tom : MRP1208T/C Floor Tom : MRP1414F/C Snare Drum : MRP1455S/C
Hardware & Accessories : H-1000, S-2000, P-1000, TH-2000L, BC-100S(x3)



WUV
P.O.D.
"Being with Pearl Drums reminds me of a great P.O.D. lyric: 'Straight up roll with the pack or get left behind.'"

Masters Premium Specifications

MMP / BMP / MRP / BRP

- Pearl's exclusive SST Superior Shell Technology
- * Light weight Aluminum OptiMount Suspension System
- * Golden Ratio Air Vents
- * Bridge Type Masters Lugs
- * Masterworks/Reference Bass Drum Spurs, Claws, and Bridge Leg Brackets and Legs
- * MasterCast Die-Cast Hoops (toms, floor toms)
- * Stainless Steel Tension Rods
- * PowerStroke 3 White Coated Bass Drum Head (in front)



Hardware Color

All Masters Premium Series drums are available with Chrome, Black Chrome, or Gold plated drum hardware.



Golden Ratio Air Vents



Light weight Aluminum OptiMount Suspension System

Masters Premium Colors

Choose from 26 super high gloss lacquer finishes, 5 premium Delmar coverings, and 3 Delmar "glass glitter" coverings with real glass flakes.



GONG DRUM
Pearl's "Gong Drum" features a 20"x14" stick-playable single-headed bass drum with twin oppositely mounted BT-3 brackets for aerial mounting. Available in Reference and Masters.

20"x14" RF2014G/C
20"x14" MMP2014G/C
20"x14" BMP2014G/C

Masters Premium Model Numbers

Specification Chart		Tom Tom	
Bass Drum		8" x 7"	0807T
24" x 18"	2418B	8" x 8"	0808T
24" x 16"	2416B	10" x 8"	1008T
22" x 20"	2220B	10" x 9"	1009T
22" x 18"	2218B	10" x 10"	1010T
22" x 16"	2216B	12" x 8"	1208T
20" x 18"	2018B	12" x 9"	1209T
20" x 16"	2016B	12" x 10"	1210T
18" x 16"	1816B	13" x 9"	1309T
18" x 14"	1814B	13" x 10"	1310T
		13" x 11"	1311T
		14" x 10"	1410T
Floor Tom		14" x 11"	1411T
14" x 14"	1414F	14" x 12"	1412T
16" x 16"	1616F	15" x 13"	1513T
18" x 16"	1816F	15" x 14"	1514T
		16" x 13"	1613T
		16" x 14"	1614T



Masters MCX

Masters MCX features the same 6 ply Maple shells and Masters quality drum hardware as its big brother, Masters Premium MRP. While Masters Premium is special order only, Masters MCX offers four ultra high gloss UV lacquer finishes and three eye-catching "glass glitter" wrapped finishes with real glass flakes, all adorned with chrome drum hardware. Standard features include Masters OptiMounts, MasterCast Die-Cast hoops, spurs, and floor tom brackets / legs. Five very affordable shell packs are available as permanent stock items. Never before has the legendary Masters sound been available to so many.

MCX 6ply [Maple]

Masters
MCX

The Most Affordable Masters Ever

Masters

Mike Wengren
Disturbed

"There is Nothing I Depend on More.
Together My Pearl Drums and I are Indestructible."



Masters MCX No. 363 Black Sparkle Fade

Bass Drum : MCX2218BX/C Tom Tom : MCX1008T/C, MCX1209T/C Floor Tom : MCX1414F/C, MCX1616F/C Snare Drum : MCX1465S/C
Hardware & Accessories : H-1000, S-1000, P-1000, T-2000, B-1000(x2), C-1000(x4)

Masters MCX No. 280 Vintage Wine

Bass Drum : MCX2218BX/C Tom Tom : MCX1008T/C, MCX1209T/C Floor Tom : MCX1616F/C Snare Drum : MCX1465S/C
Hardware & Accessories : H-2000, S-2000, P-2000C, TC-1000(2X)

Darryl Kerec
Shinedown

"Pearl Drums hold up to the rigors of the road and the stress of the studio, I have never been happier."



Legendary Sound

The foundation of the legendary Masters sound starts with a 6 ply, 100% select Maple shell. The warm, full tone of Pearl's Maple shell has been the first choice of professional drummers worldwide for decades. At a new low price, the legend lives on with Masters MCX.

Masters MCX Specifications

- * Pearl's exclusive SST Superior Shell Technology
- * OptiMount Suspension System
- * Bridge Type Masters Lugs
- * Standard Masters Bass Drum Spurs, Claws and Bridge Type Leg Brackets
- * MasterCast Die-Cast Hoops (toms, floor toms)
- * Standard Steel Tension Rods
- * Coated PowerStroke 3 Ebony Bass Drum Head (in front)



Masters MCX Color



JUNGLE GIG

The Jungle Gig allows the conversion of virtually any 16" floor to a bass drum. Very portable and perfect for small gigs.

Jungle Gig Kit JG-16

ROCKET TOMS

Rocket Toms are the perfect accent for your kit and can be melodically tuned for dramatic fills.

6" x 12"	AL-612
6" x 15"	AL-615
6" x 18"	AL-618
6" x 21"	AL-621

#103 Piano Black Lacquer,
#109 Arctic White Lacquer

Masters MCX Model Numbers

Specification Chart

Bass Drum		Tom Tom	
24" x 18"	MCX2418BX/C	8" x 7"	MCX0807T/C
24" x 16"	MCX2416BX/C	8" x 8"	MCX0808T/C
22" x 18"	MCX2218BX/C	10" x 8"	MCX1008T/C
22" x 16"	MCX2216BX/C	10" x 9"	MCX1009T/C
20" x 18"	MCX2018BX/C	10" x 10"	MCX1010T/C
20" x 16"	MCX2016BX/C	12" x 8"	MCX1208T/C
18" x 16"	MCX1816BX/C	12" x 9"	MCX1209T/C
18" x 14"	MCX1814BX/C	12" x 10"	MCX1210T/C
		13" x 9"	MCX1309T/C
		13" x 10"	MCX1310T/C
		13" x 11"	MCX1311T/C
		14" x 11"	MCX1411T/C
		14" x 12"	MCX1412T/C
		15" x 13"	MCX1513T/C
		15" x 14"	MCX1514T/C
		16" x 13"	MCX1613T/C
		16" x 14"	MCX1614T/C

Floor Tom

VISION

VMX | VBX | VSX & VX |
100% Maple | 100% Birch | Birch Ply

Next Level Perfection

Pearl originally created the now legendary Export Series to deliver quality drums at an affordable price.

Export spent the next 20 years as the number one selling drumset in the world. The lessons learned from this extraordinary success led

Pearl to create a new series of drums that far exceeds the standard set by Export.

Welcome to Pearl's Vision Series, the highest quality drums in their class, period.

The Vision of 6/8

Some companies in the intermediate category have chosen to compromise quality and features in exchange for a low price. Pearl will never make that sacrifice. The Vision Series represents Pearl's commitment to quality by including more professional features while maintaining an affordable price. Vision drumsets feature two very different shell thicknesses: 6 plies on rack toms and 8 plies on bass drums and floor toms, for incredibly balanced sound. Lower frequencies require greater energy, provided by a projection of the higher frequencies produced by smaller drums. Vision's unique 6/8 technology makes this possible. Vision's exclusive two-ply heads are easier to tune, and deliver full, powerful sound right out of the box. With the exception of the Vision Maple shell pack, Vision drumsets feature Pearl's M.I.P.A. (Music Industry Press Association) award-winning 900 series hardware. From the Birch Ply shell of VX to the 100% Maple shell of VMX, Vision is the next level of perfection for the drummer who can tell the difference.



Vision's Professional Features

- Pearl's Exclusive SST Superior Shell Technology
- Infinitely Adjustable "UNI-LOCK" system tom holders (VX comes with TH-88 Gear Tilter Tom Holders)
- Professional I.S.S Tom Mounting System
- Bridge Type Lugs, Tom holder Base and Leg Brackets (VMX comes with BB-3 tom holder base, LB-40 leg brackets.)
- Air Suspension Floor Tom Feet
- ProTone Perimeter EQ Bass Drum Heads
- VMX, VBX, VSX comes with ProTone 2 ply heads.

Professional 900 Series Hardware

- (VSX, VBX, VX)
- Infinitely Adjustable "UNI-LOCK" system cymbal tilter
 - Die-Cast Joint w/Stop Lock
 - Rattle-less "SureStrut" tripod base
- (VMX is available in shell pack only. 900 Series Hardware not included.)



Vision

Mike Mangini
World's Fastest Drummer

"My relationship with Pearl is dynamic in nature, meaning that both the products and my expression improve and evolve over time. If any type of relationship is to be successful, then it must adapt to its environment and change over time. Pearl does this."



VISION VMX No. 280 Vintage Wine

Bass Drum : VMX2218B/C Tom Tom : VMX1008T/C, VMX1209T/C Floor Tom : VMX1414F/C, VMX1616F/C Snare Drum : VMX1455S/C
Hardware & Accessories : H-1000, S-1000, P-1000, TH-1000(x2), B-1000, C-1000

Vision Maple **VMX**

100% Maple Shell 

Introducing the all-new VMX, Pearl's most affordable 100% Maple shell pack. Maple, known for its warm, rich tone, has long been the choice wood of professional drummers worldwide. Pearl offers 9 standard Shell Pack configurations, more than any other drum manufacturer. Vision Maple shell packs come standard with professional Two Ply heads and a matching 100% Maple snare drum. These incredible sounding drums are offered in 5 exclusive High-Gloss Lacquer Finishes. VMX is available in shell pack only, no hardware included.

Vision VMX Color



Matching 6-ply 100% Maple snare drum

Vision VMX Model Numbers Specification Chart

Bass Drums	
VMX2218B/C	22" x 18"
VMX2018B/C	20" x 18"
VMX2418B/C	24" x 18"
Floor Toms	
VMX1414F/C	14" x 14"
VMX1616F/C	16" x 16"
VMX1816F/C	18" x 16"
Tom Toms	
VMX0807T/C	8" x 7"
VMX1008T/C	10" x 8"
VMX1209T/C	12" x 9"
VMX1310T/C	13" x 10"
VMX1411T/C	14" x 11"
VMX1613T/C	16" x 13"



VISION VMX No. 309 Glacier White

Bass Drum : VMX2218B/C Tom Tom : VMX1209T/C Floor Tom : VMX 1414F/C, VMX1616F/C Snare Drum : VMX1455S/C
Hardware & Accessories : H-900, S-900, P-900, TH-1000, BC-900, C-900

Morgan Rose
Sevendust

"In my 4 years with Pearl, they have NEVER let me down!!! I love the fact that when your with Pearl, you're with family."



Vision Birch **VBX**

100% Birch Shell 

Introducing the all-new VBX, Pearl's most affordable 100% Birch drum set. Birch has long been recognized for its focused, naturally EQ'd sound, ideal for both stage and studio. Pearl offers 9 standard VBX configurations, more than any other drum manufacturer. VBX come standard with professional Two Ply heads, a Steel SensiTone snare drum, and Award-Winning 900 Series Hardware. These incredible sounding drums are offered in 5 exclusive High-Gloss Lacquer Finishes.



Blake Dixon
Saving Abel

"I don't even have to think about my drums, they're Pearl... nuff said."



Vision VBX Model Numbers
Specification Chart

Bass Drums	
VBX2218B/C	22" x 18"
VBX2018B/C	20" x 18"
VBX2418B/C	24" x 18"
Floor Toms	
VBX1414F/C	14" x 14"
VBX1616F/C	16" x 16"
VBX1816F/C	18" x 16"
Tom Toms	
VBX0807T/C	8" x 7"
VBX1008T/C	10" x 8"
VBX1209T/C	12" x 9"
VBX1310T/C	13" x 10"
VBX1411T/C	14" x 11"
VBX1613T/C	16" x 13"

Vision VBX Color

		NEW
No. 230 Clear Birch	No. 232 Ruby Fade	
		
No. 234 Black Ice	No. 235 Concord Fade w/Black HW	No. 237 Harvest Fade



VBX drumsets include a SensiTone Steel snare drum

VISION VBX No.235 Concord Fade
VBX925FP/B

VISION VBX No.237 Harvest Fade
VBX925/C



Cody Hanson
Hinder

"The bottom line is, no other company can compete with Pearl!"

Vision
VISION

VSX&VX
Birch Ply Shell



Based on the original Vision formula, VSX and VX drumsets feature blended Birch Ply shells with 6/8 shell technology. Vision's combination of six-ply rack toms and eight-ply floor toms and bass drums deliver a dynamically balanced sound. Pearl offers 9 standard Vision configurations, more than any other drum manufacturer. VSX and VX come standard with a Brushed Steel SensiTone snare drum, and Award-Winning 900 Series Hardware. VSX offers 6 Ultra-Exotic wrapped coverings, while VX offers 6 more affordable solid color wrap options.



VSX & VX drumsets include a Brushed Steel SensiTone snare drum



Brian Vodinh
10 YEARS

"I can't imagine being on tour without Pearl, the reliability and great sound are a constant every night."

VSX

Vision VSX Model Numbers
Specification Chart

Bass Drums		Tom Toms	
VSX2218B/C	22" x 18"	VSX0807T/C	8" x 7"
VSX2018B/C	20" x 18"	VSX1008T/C	10" x 8"
VSX2418B/C	24" x 18"	VSX1209T/C	12" x 9"
Floor Toms		VSX1310T/C	13" x 10"
VSX1414F/C	14" x 14"	VSX1411T/C	14" x 11"
VSX1616F/C	16" x 16"	VSX1613T/C	16" x 13"
VSX1816F/C	18" x 16"		

Vision VSX Color



VX

Vision VX Model Numbers
Specification Chart

Bass Drums		Tom Toms	
VX2218B/C	22" x 18"	VX0807T/C	8" x 7"
VX2018B/C	20" x 18"	VX1008T/C	10" x 8"
VX2418B/C	24" x 18"	VX1209T/C	12" x 9"
Floor Toms		VX1310T/C	13" x 10"
VX1414F/C	14" x 14"	VX1411T/C	14" x 11"
VX1616F/C	16" x 16"	VX1613T/C	16" x 13"
VX1816F/C	18" x 16"		

Vision VX Color

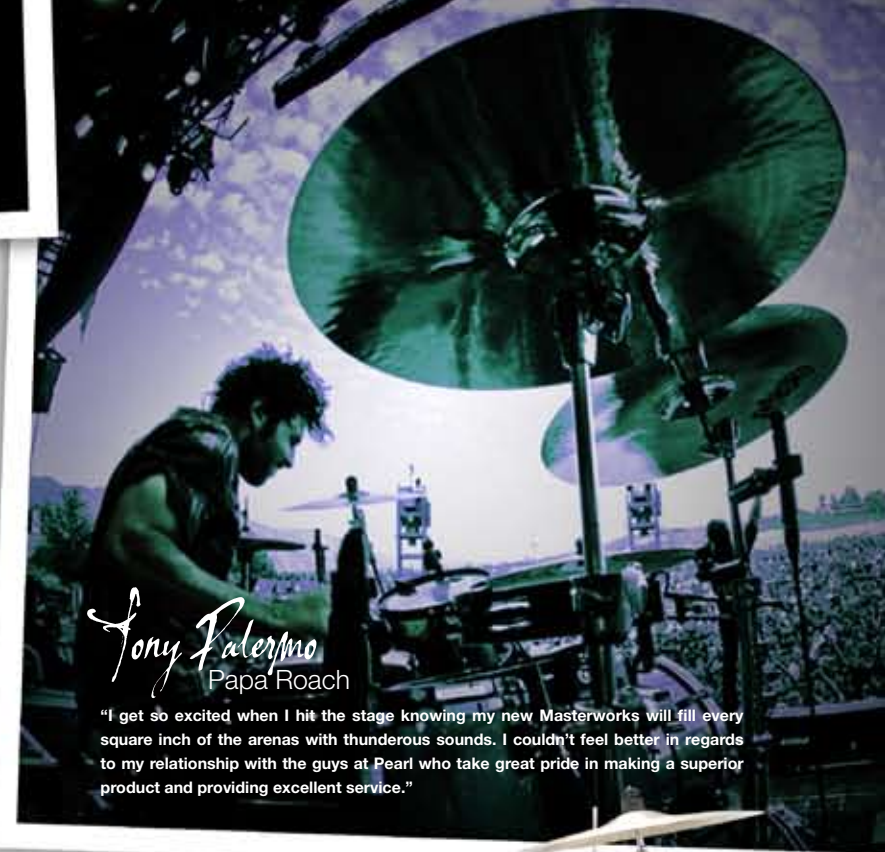

Tony Palermo
Papa Roach

"I get so excited when I hit the stage knowing my new Masterworks will fill every square inch of the arenas with thunderous sounds. I couldn't feel better in regards to my relationship with the guys at Pearl who take great pride in making a superior product and providing excellent service."



VISION VSX No.431 Strata Black
VSX925S/C

VISION VSX No.444 Orange Sparkle
VSX925S/C

VISION VX No.43 RB Blue
VX924/C

FORUM FZ

Forum Ready-Set-Go! is the all-in-one concept that gets you started in style and ready to rock right out of the box. With new upgrades, Forum is better than ever, and is the ideal choice for the beginning drummer. New features in 2008 include I.S.S. tom mounts, newly designed low-mass lugs, improved cymbals, with a new 16" crash, and the addition of slick black drum hardware, standard on two of the five flashy Forum finishes. Forum comes with rugged double-braced hardware, a heavy duty throne, a pair of Vic Firth drumsticks, and a free DVD with all the set-up, tuning and instructional pointers you'll need to get started. There's no better way to start your drumming career than with Pearl Forum Ready-Set-Go!



Forum FZ
No.91 Red Wine
FZ725/B

Forum FZ Model Numbers Specification Chart

/C : Chrome Drum Hardware, /B : Black Drum Hardware

	FZ725F	FZ725	FZ705
Bass Drum	2218B 22"x18"	2218B 22"x18"	2016B 20"x16"
Tom Toms	1008T 10"x8"	1209T 12"x9"	1008T 10"x8"
	1209T 12"x9"	1310T 13"x10"	1209T 12"x9"
Floor Tom	1414F 14"x14"	1616F 16"x16"	1414F 14"x14"
Snare Drum	1455S 14"x5.5"	1455S 14"x5.5"	1455S 14"x5.5"
Ride Cymbal	20"	20"	20"
Crash Cymbal	16"	16"	16"
Hi-Hat Cymbals	14" (1pr.)	14" (1pr.)	14" (1pr.)
Tom Holders	TH-70I (x2)	TH-70I (x2)	TH-70I (x2)
Hi-Hat Stand	H-72W	H-72W	H-72W
Snare Drum Stand	S-70W	S-70W	S-70W
Cymbal Stand	C-70W	C-70W	C-70W
Cymbal/Boom Stand	B-70W	B-70W	B-70W
Drum Pedal	P-120P	P-120P	P-120P
Drum Throne	D-70W	D-70W	D-70W
Drumsticks	Vic Firth 5A	Vic Firth 5A	Vic Firth 5A
DVD	An Introduction to Drumming featuring Eric Singer		

Forum FZ Color

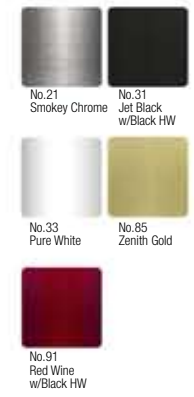

Pearl I.S.S. Mounts
Pearl's I.S.S. tom mounting system removes all mounting hardware from the shell and clamp to the rim providing the quickest and easiest mounting system available today.



NEW
Forum FZ
This configuration FZ724E/B only available in Smokey Chrome & Jet Black with black drum hardware.

Rhythm Traveler



Plastic Heads & Real Cymbals for Live Playing
Muffle Heads(mesh) & Plastic Cymbals for Silent Practicing

Easy to transport and easy to practice, the ground breaking concept kit Rhythm Traveler is a gigging and practice kit in one. This complete 5pc kit includes professional quality 2 ply "ProTone" heads and 13" and 16" cymbals for live performance, and silent mesh heads and plastic cymbals for near-silent practicing.



RT705HBC
No.31 Jet Black

Rhythm Traveler

Rhythm Traveler Specification Chart
(HCC* : Chrome Drum Hardware, HBC : Black Drum Hardware)

Bass Drum	2008B	20"x8"
Tom Toms	1005T	10"x5"
	1205T	12"x5"
	1405T	14"x5"
Snare Drum	1305S	13"x5"
Crash -Ride Cymbal	CX216	16"
Hi-Hat Cymbals	CX213	13" (1pr.)
Cymbal Pads	RP-CP (x2)	for Ride and Hi-Hat Cymbals
Plastic Cymbals	RP-13PRC (for Ride)	
	RP-13PHH (for Hi-Hat)	
Heads	PTH-13 (Snare Drum)	
	PTH-10/PTH-12/PTH-14 (Tom Toms)	
	PTH-20EQ (Bass Drum)	
Mesh Heads	MFH-13 (Snare Drum)	
	MFH-10/MFH-12/MFH-14 (Tom Toms)	
	MFH-20 (Bass Drum)	
Tom Holders	TH-60 (x2), TH-60S	
Adapter	ADT-2	
Hi-Hat Stand	H-62W	
Snare Drum Stand	S-62W	
Cymbal Stand	C-62W	
Drum Pedal	P-62	

Available Finishes

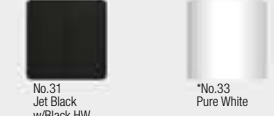

*Not available in U.S.

Pearl Snare Drums

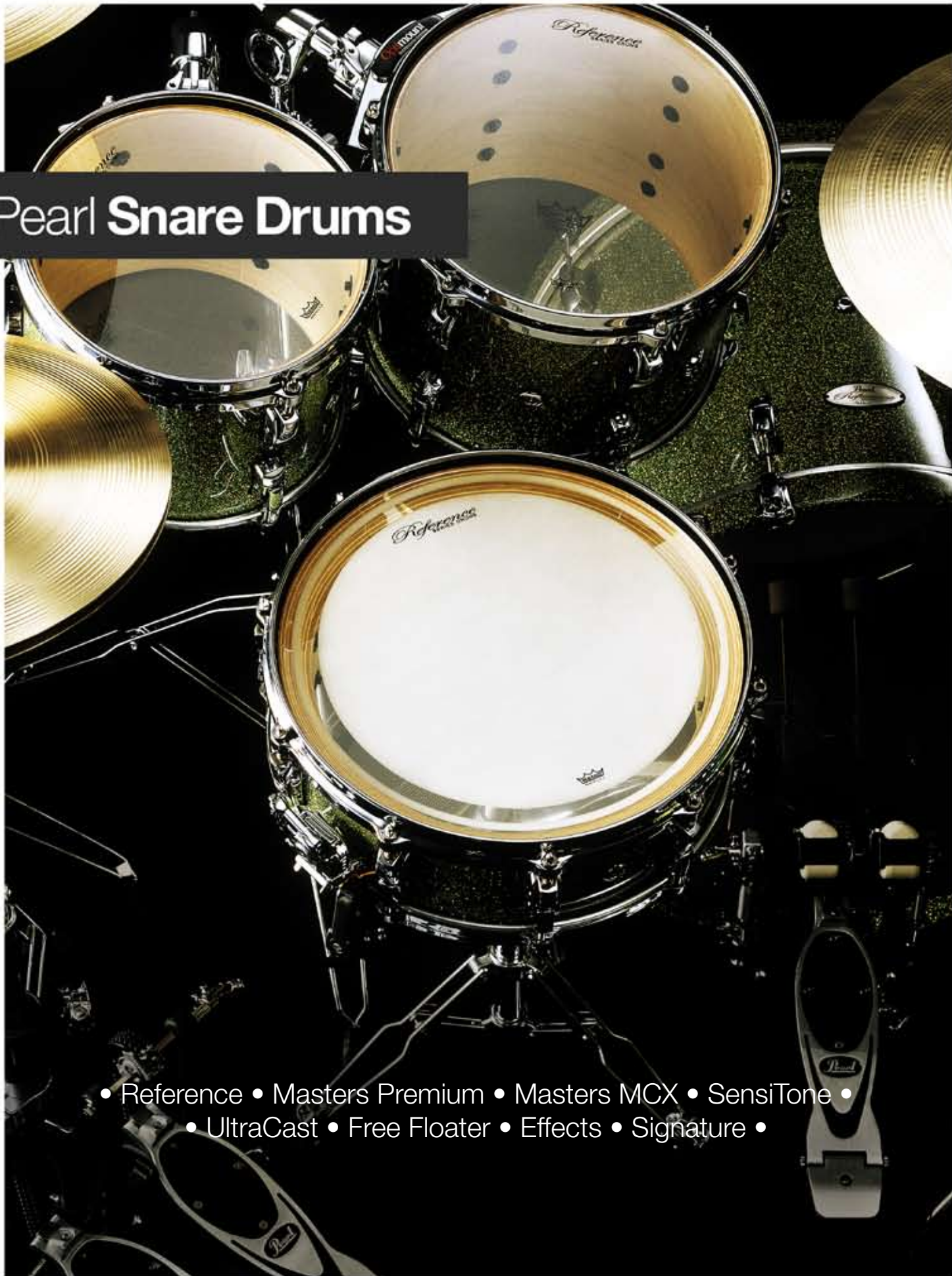

- Reference • Masters Premium • Masters MCX • SensiTone •
- UltraCast • Free Floater • Effects • Signature •

Reference

Reference Series wood snare drums feature 20 ply shells, with 6 inner plies of Birch and 14 outer plies of Maple, making it one of the loudest wood snare drums available. The 6 inner plies of Birch provides cut and attack while the outer 14 plies of Maple provide warmth and solid midrange punch. The shell's 45 degree bearing edge provides minimum head dampening for intense crack and attack. Reference Series metal snare drums redefine the standard for metal snare drums, just as our wood Reference Series snare

drums did for wood snare drums. Both feature Reference swivel lugs for perfect tension rod alignment, MasterCast die cast hoops, SR-1000 Glide Lock strainer with patented locking lever that prevents the throw-off from disengaging no matter how hard you play, and UltraSound SN-1420D Graduated Tension Snares for extended dynamic range and sensitivity.

Wood Shell

Reference Snare Drums offer a level of performance unattainable before now. 6 inner plies of Birch unite with 14 outer plies of Maple for a staggering 20 ply shell. The 45 degree bearing edge brings all 20 plies to the party in a highly focused sweet spot. This projects the volume that you would expect from such a thick shell without losing sensitivity or articulation. The state-of-the-art in modern hardware adorns these snares to maximize every nuance of the shell construction. Available in 3 sizes to perfectly suit your personal level of performance.



SR-1000
Glide-Lock Strainer
US.PAT.7220905/7301087



	RF1465S/C		RF1450S/C		RF1365S/C	
Size (Dia. x Depth)	14" x 6.5"		14" x 5"		13" x 6.5"	
Shell	20ply : Maple14 + Birch6		20ply : Maple14 + Birch6		20ply : Maple14 + Birch6	
Hoops	MasterCast (DC1410/1410S)		MasterCast (DC1410/1410S)		MasterCast (DC1306/1306S)	
Lugs	BRL-65		BRL-55		BRL-65	
Rods	10		10		6	
Tension Rods	SST-5047	Stainless Steel Tension Rod	SST-5047	Stainless Steel Tension Rod	SST-5047	Stainless Steel Tension Rod
Strainer	SR-1000	Glide-Lock Strainer	SR-1000	Glide-Lock Strainer	SR-1000	Glide-Lock Strainer
Snares	SN-1420D	Ultra-Sound "D" Type	SN-1420D	Ultra-Sound "D" Type	SN-1320D	Ultra-Sound "D" Type

Brass & Cast Steel Shell

Reference Series offers the most advanced Metal snare drums in the World. The winning combination of extreme sensitivity and powerful volume makes these snare drums a must-have instrument for the working drummer. Whether you choose the "wet and ringy" tone of 3 mm Brass or the brightly assertive 2.5 mm Cast Steel, these drums will satisfy the most demanding of players.



Brass



	RFB1465		RFB1450	
Size (Dia. x Depth)	14" x 6.5"		14" x 5"	
Shell	3mm Brass		3mm Brass	
Hoops	MasterCast (DC1410/1410S)		MasterCast (DC1410/1410S)	
Lugs	BRL-65		BRL-55	
Rods	10		10	
Tension Rods	SST-5047	Stainless Steel Tension Rod	SST-5047	Stainless Steel Tension Rod
Strainer	SR-1000	Glide-Lock Strainer	SR-1000	Glide-Lock Strainer
Snares	SN-1420D	Ultra-Sound "D" Type	SN-1420D	Ultra-Sound "D" Type



Cast Steel



	RFS1465		RFS1450	
Size (Dia. x Depth)	14" x 6.5"		14" x 5"	
Shell	2.5mm Cast Steel w/ Reinforcement		2.5mm Cast Steel w/ Reinforcement	
Hoops	MasterCast (DC1410/1410S)		MasterCast (DC1410/1410S)	
Lugs	BRL-65		BRL-55	
Rods	10		10	
Tension Rods	SST-5047	Stainless Steel Tension Rod	SST-5047	Stainless Steel Tension Rod
Strainer	SR-1000	Glide-Lock Strainer	SR-1000	Glide-Lock Strainer
Snares	SN-1420D	Ultra-Sound "D" Type	SN-1420D	Ultra-Sound "D" Type

Masters

Masters Premium & Masters MCX

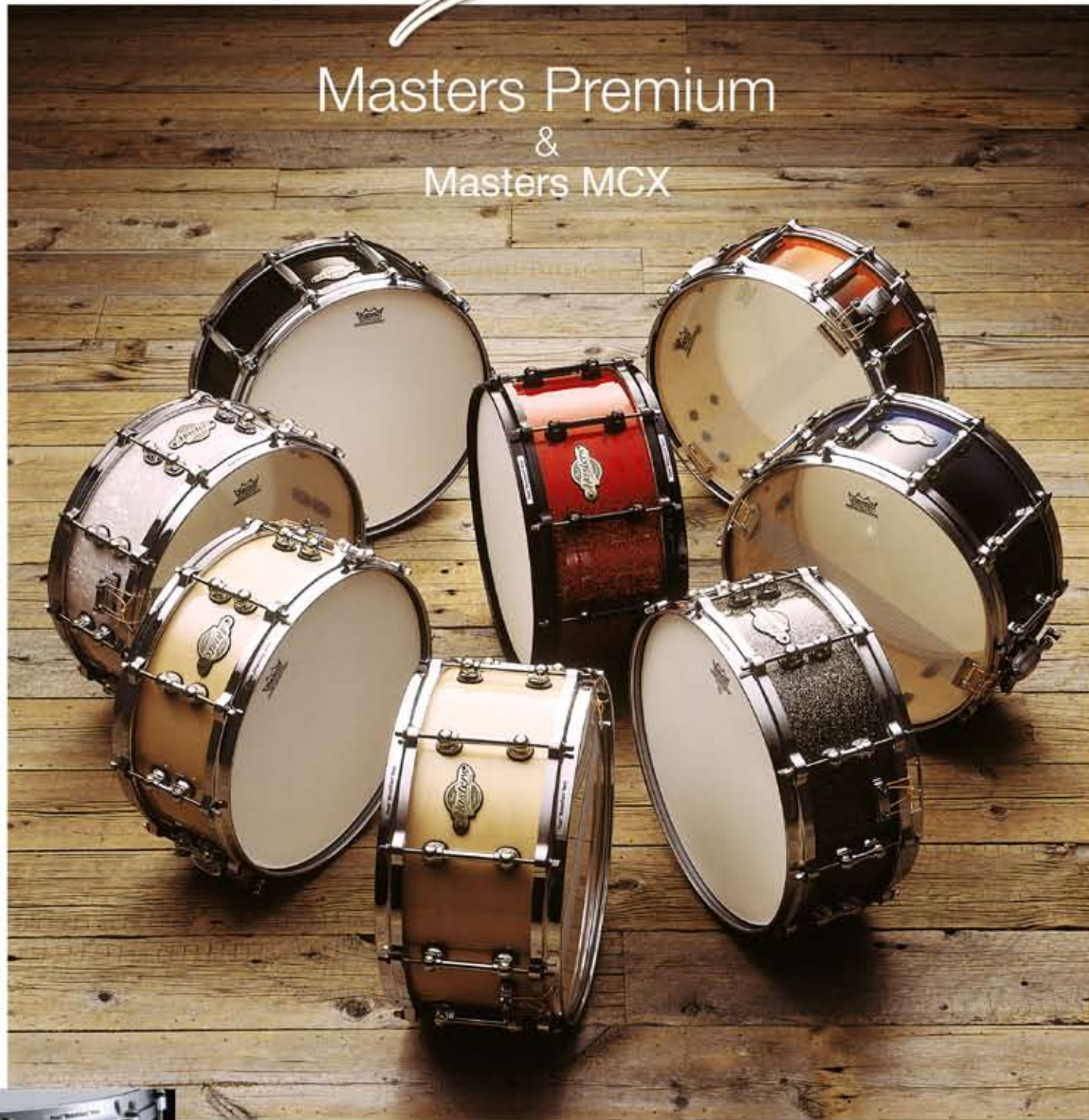

Pearl's Masters Premium Series snare drums feature revolutionary swivel lugs that assure perfect tension rod to lug alignment for optimal head seating and precision tuning. MasterCast die-cast hoops, stainless steel tension rods, innovative "Golden Ratio" air vents for increased attack, and a "vertical pull" SR-017 strainer all come standard on these spectacular snare drums. Masters Premium snare drums are available in a total of 31 finishes including 26 super high gloss lacquer finishes and 8 premium Delmar covered finishes, 3 of which are glass glitter finishes with real glass flakes for incredible radiance.

Matt McDonough
Mudvayne

"Pearl is always at the front of the pack with new and innovative snare drums."

Masters Premium



	MMP1465S/C	MRP1455S/C	BMP1465S/C
Size (Dia. x Depth)	14" x 6.5"	14" x 5.5"	14" x 6.5"
Shell	4 ply Maple w/4ply Maple Reinforcement Rings	6 ply Maple	4 ply Birch w/4ply Birch Reinforcement Rings
Hoops	MasterCast (DC1410/1410S)	MasterCast (DC1410/1410S)	MasterCast (DC1410/1410S)
Lugs	STL-65	STL-55	STL-65
Rods	10	10	10
Tension Rods	SST-5047 Stainless Steel Tension Rod	SST-5055 Stainless Steel Tension Rod	SST-5047 Stainless Steel Tension Rod
Strainer	SR-017	SR-017	SR-017
Snares	S-022N	S-022N	S-022N



	BMP1455S/C	BRP1465S	BRP1455S/C
Size (Dia. x Depth)	14" x 5.5"	14" x 6.5"	14" x 5.5"
Shell	4 ply Birch w/4ply Birch Reinforcement Rings	6 ply Birch	6 ply Birch
Hoops	MasterCast (DC1410/1410S)	MasterCast (DC1410/1410S)	MasterCast (DC1410/1410S)
Lugs	STL-55	STL-65	STL-55
Rods	10	10	10
Tension Rods	SST-5055 Stainless Steel Tension Rod	SST-5047 Stainless Steel Tension Rod	SST-5055 Stainless Steel Tension Rod
Strainer	SR-017	SR-017	SR-017
Snares	S-022N	S-022N	S-022N

Masters MCX



	MCX1465S/C	MCX1455S/C	MCX1455S/C
Size (Dia. x Depth)	14" x 6.5"	14" x 5.5"	14" x 5.5"
Shell	6 ply Maple	6 ply Maple	6 ply Maple
Hoops	MasterCast (DC1410/1410S)	MasterCast (DC1410/1410S)	MasterCast (DC1410/1410S)
Lugs	CL-65	CL-55	CL-55
Rods	10	10	10
Tension Rods	T-061L	T-062	T-062
Strainer	SR-017	SR-017	SR-017
Snares	S-022N	S-022N	S-022N



SensiTone Elite

SensiTone Elite snare drums offer unparalleled options for the discriminating drummer of today. This series provides a virtual cauldron of advanced metallurgy with a choice of 1mm Steel, 1.2mm Stainless Steel, 1.5mm Brass, 1.2mm Phosphor Bronze and 1.2mm seamless Aluminum. Each of these instruments brings a distinctive sound inherent to its individual aural alchemy. Choosing one will be tough, may we suggest collecting the whole series?



Brass

Phosphor Bronze

Aluminum

Stainless Steel

Steel



STE1465BR



STE1465PB



STE1465AL



STE1465SS



STE1465S



STE1450BR



STE1450PB



STE1450AL



STE1450SS



STE1450S

Size (Dia. x Depth)	STE1465BR 14" x 6.5"	STE1450BR 14" x 5"	STE1465PB 14" x 6.5"	STE1450PB 14" x 5"	STE1465AL 14" x 6.5"	STE1450AL 14" x 5"	STE1465SS 14" x 6.5"	STE1450SS 14" x 5"	STE1465S 14" x 6.5"	STE1450S 14" x 5"
Shell	1.5 mm Brass w/Black Nickel Plating	1.5 mm Brass w/Black Nickel Plating	1.2mm Phosphor Bronze	1.2mm Phosphor Bronze	1.2mm Seamless Aluminum	1.2mm Seamless Aluminum	1.2mm Stainless Steel	1.2mm Stainless Steel	1mm Steel w/Chrome Plating	1mm Steel w/Chrome Plating
Hoops	SuperHoop II	SuperHoop II	SuperHoop II	SuperHoop II	SuperHoop II	SuperHoop II	SuperHoop II	SuperHoop II	SuperHoop II	SuperHoop II
Lugs	STE1465BR CL-65	STE1450BR CL-55	STE1465PB CL-65	STE1450PB CL-55	STE1465AL CL-65	STE1450AL CL-55	STE1465SS CL-65	STE1450SS CL-55	STE1465S CL-65	STE1450S CL-55
Rods	10	10	10	10	10	10	10	10	10	10
Tension Rods	SST-5047 Stainless Steel Tension Rod	SST-5047 Stainless Steel Tension Rod	SST-5047 Stainless Steel Tension Rod	SST-5047 Stainless Steel Tension Rod	SST-5047 Stainless Steel Tension Rod	SST-5047 Stainless Steel Tension Rod	SST-5047 Stainless Steel Tension Rod	SST-5047 Stainless Steel Tension Rod	SST-5047 Stainless Steel Tension Rod	SST-5047 Stainless Steel Tension Rod
Strainer	SR-017	SR-017	SR-017	SR-017	SR-017	SR-017	SR-017	SR-017	SR-017	SR-017
Snares	SN-1420I Ultra-Sound "I" Type	SN-1420I Ultra-Sound "I" Type	SN-1420I Ultra-Sound "I" Type	SN-1420I Ultra-Sound "I" Type	SN-1420I Ultra-Sound "I" Type	SN-1420I Ultra-Sound "I" Type	SN-1420I Ultra-Sound "I" Type	SN-1420I Ultra-Sound "I" Type	SN-1420I Ultra-Sound "I" Type	SN-1420I Ultra-Sound "I" Type

UltraCast

UltraCast has turned into a modern gothic novel. An experiment gone awry. A monster in the truest sense. We set out to make a precision milled cast Aluminum shell that would project energy and be heard over the chaos of a live band. UltraCast has done that beyond our wildest dreams.

When you hear players like Morgan Rose, Sam Loeffler (Chevelle), and Kris Myers (Umphrey's McGee), you're hearing the power of UltraCast. Available in 2 sizes, only one attitude.



SR-1000 Glide-Lock Strainer

US.PAT.7220905/7301087



UCA1465/B



UCA1450/B

Size (Dia. x Depth)	UCA1465/B 14" x 6.5"	UCA1450/B 14" x 5"
Shell	3mm Cast Aluminum w/Reinforcement	3mm Cast Aluminum w/Reinforcement
Hoops	SuperHoop II (SHB1410B/1410S)	SuperHoop II (SHB1410B/1410S)
Lugs	TB-65B	TB-50B
Rods	10	10
Tension Rods	SST-5042 Stainless Steel Tension Rod	SST-5042 Stainless Steel Tension Rod
Strainer	SR-1000 Glide-Lock Strainer	SR-1000 Glide-Lock Strainer
Snares	SN-1420C Ultra-Sound "C" Type	SN-1420C Ultra-Sound "C" Type



The SR-900 Duo-Motion strainer can be converted from side lever action to Gladstone type.

SensiTone Steel (Vision Series)



SS1455S/C



SH1455S/C

Size (Dia. x Depth)	SS1455S/C 14" x 5.5"	SH1455S/C 14" x 5.5"
Shell	Steel w/Chrome Plating	Brushed Nickel Plated Steel
Hoops	1mm Steel (RIM1408B/1408S)	1mm Steel (RIM1408B/1408S)
Lugs	TLS-55	TLS-55
Rods	8	8
Tension Rods	TR-5052	TR-5052
Strainer	SR-900 Duo-Motion Strainer	SR-900 Duo-Motion Strainer
Snares	SNN-1420	SNN-1420



Free Floating System

Pearl Free Floating Snares feature a patented system with no hardware attached to the shells. With nothing to encumber its ringing clarity the shells are free to vibrate with unbridled response and truest articulation. Pearl Free Floating System snare drums are available in several sizes and 4 different shell materials: Brass, Copper, Steel and 6 ply premium Maple. All Free Floaters feature our SR-1000F Glide-Lock Strainer with locking snare tension knob and patented locking throwoff lever that will not loosen no matter how hard you play.



SR-1000
Glide-Lock Strainer
US.PAT.7220905/7301087

Shell	6 Ply Maple	Brass	Copper
Size (Dia. x Depth)	14" x 6.5"		
Hoops	MasterCast (DC1410/DC1410S)		
Lugs	FT-65		
Rods	10		
Tension Rods	SST-5042	Stainless Steel Tension Rod	
Strainer	SR-1000F	Glide-Lock Strainer	
Snares	SN-1420I	Ultra-Sound "I" Type	
	FM1465/C	FB1465/C	FC1465/C
Size (Dia. x Depth)	14" x 5"		
Hoops	MasterCast (DC1410/DC1410S)		
Lugs	FT-50		
Rods	10		
Tension Rods	SST-5042	Stainless Steel Tension Rod	
Strainer	SR-1000F	Glide-Lock Strainer	
Snares	SN-1420I	Ultra-Sound "I" Type	
	FM1450/C	FB1450/C	FC1450/C
Size (Dia. x Depth)	14" x 3.5"		
Hoops	MasterCast (DC1410/DC1410S)		
Lugs	FT-35		
Rods	10		
Tension Rods	SST-5035	Stainless Steel Tension Rod	
Strainer	SR-1000F	Glide-Lock Strainer	
Snares	SN-1420I	Ultra-Sound "I" Type	
	FM1435/C	FB1435/C	FC1435/C

Pearl Snare Drums

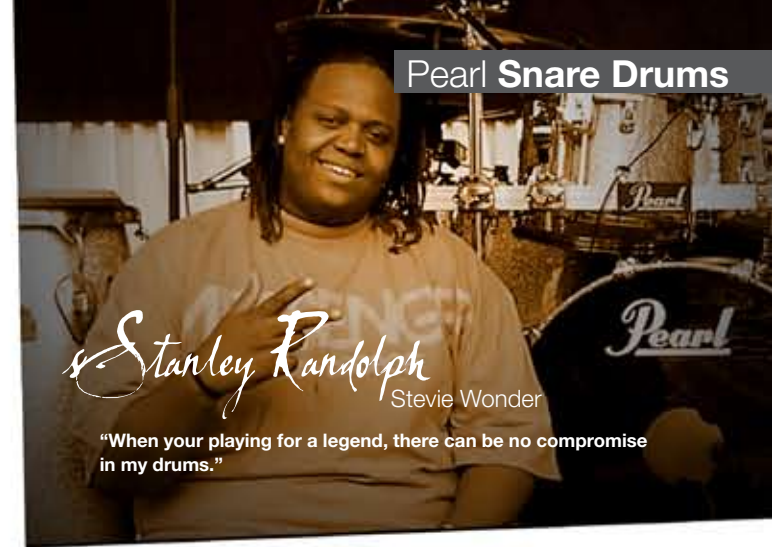

Stevie Wonder
Stevie Wonder

"When your playing for a legend, there can be no compromise in my drums."

Shell	Steel
Size (Dia. x Depth)	14" x 3.5"
Hoops	1.6mm Steel (RIM1410B/1410S)
Lugs	FT-35
Rods	10
Tension Rods	T-060
Strainer	SR-1000F Glide-Lock Strainer
Snares	SN-1420I Ultra-Sound "I" Type
	FB1435B/C

FireCracker

When you're ready to add sparks to your playing, the first thing to do is to add a FireCracker snare drum.

As the name implies these explosive powerhouses deliver huge sound from a small package. FireCracker snare drums are available in 12" x 5" and 10" x 5" sizes in your choice of 8 ply Poplar or Steel. Light the fuse and stand back!



	FCS1050	FCS1250	FCP1050	FCP1250
Size (Dia. x Depth)	10" x 5"	12" x 5"	10" x 5"	12" x 5"
Shell	1.0mm Steel	1.0mm Steel	8ply Poplar	8ply Poplar
Hoops	1.6mm Steel (RIM1006/1006SL)	1.6mm Steel (RIM1206/1206S)	1.6mm Steel (RIM1006/1006SL)	1.6mm Steel (RIM1206/1206S)
Lugs	CL-50	CL-50	CL-50	CL-50
Rods	6	6	6	6
Tension Rods	T-062	T-062	T-062	T-062
Strainer	SR-018	SR-018	SR-018	SR-018
Snares	S-032	S-031	S-032	S-031

Effect

These versatile drums can be used for secondary effects or as your main snare drum. They're available in a range of sizes to complement any musical style.



	M1040	Sopranino	M1060	Popcorn	M1270	Soprano	B1330	Piccolo	S1330B	Piccolo	M1330	Piccolo	M1440	Piccolo
Size (Dia. x Depth)	10" x 4"		10" x 6"		12" x 7"		13" x 3"		13" x 3"		13" x 3"		14" x 4"	
Shell	6 ply Maple		6 ply Maple		8 ply Maple		Brass		Steel		6 ply Maple		6 ply Maple	
Hoops	1.6mm Steel (RIM1006/1006SL) w/1.S.S.		SuperHoop II (SH1006/1006S)		1.6mm Steel (RIM1208B/1208S)		1.6mm Steel (RIM1308B/1308S)		1.6mm Steel (RIM1308B/1308S)		1.6mm Steel (RIM1308B/1308S)		1.6mm Steel (RIM1410B/1410S)	
Lugs	CL-05		CL-65		CL-100		CL-05		CL-05		CL-05		CL-05	
Rods	6		6		8		8		8		8		10	
Tension Rods	SST-5038 Stainless Steel Tension Rod		SST-5035 Stainless Steel Tension Rod		SST-5047 Stainless Steel Tension Rod		T-055		T-055		T-055		SST-5042	
Strainer	SR-018		SR-018		SR-018		SR-018		SR-018		SR-018		SR-018	
Snares	S-032N		S-032N		S-031N		S-029N		S-029N		S-029N		S-022N	

Signature Series

Imagine being able to capture the elusive sound of your drumming idol. Pearl's extensive line of Signature Series Snares gives you an opportunity to own a snare developed with input from the pros. We offer snares from some of the world's greatest players, and they're all available at your Pearl Dealer.



Jimmy DeGrasso
Jimmy has laid the foundation for such hard rock acts as Alice Cooper, Ozzy Osbourne, Suicidal Tendencies and most notably, the multi-platinum Megadeth. Jimmy's Signature Snare Drum is a 14"x 5.5" hammered brass snare drum with gold-plated hardware, ideal for loud, amplified music. This striking drum is sure to catch the eyes and ears of all drummers.



JD1455
Size (Dia. X Depth) : 14" X 5.5"
Shell : 1mm Beaded, Hammered Brass
Hoops : SuperHoop II / Gold Plated (SHG1410 / 1410)
Lugs : CL-55G
Rods : 10
Tension Rods : SST-5052 Stainless Steel Tension Rod
Strainer : SR-017G
Snares : S-1420D Ultra-Sound "D" Type



Ian Paice
Deep Purple's legendary drummer designed this snare drum to have classic looks and classic sound with modern technology. The 6.5" steel shell will give you a big rock sound, and the locking nuts will help your drum to "stay tuned all night".





IP1465
Size (Dia. X Depth) : 14" X 6.5"
Shell : Beaded Sheet Steel
Hoops : SuperHoop II (SH1410 / 1410S)
Lugs : TB-65
Rods : 10
Tension Rods : SST-5042 Stainless Steel Tension Rod
Strainer : SR-017
Snares : S-022N



Mike Mangini
Mike is recognized as one of the fastest drummers alive and actually set the world record for a single stroke roll with 1,247 strokes in 60 seconds. He has recorded and toured with such acts as Steve Vai, Extreme and Annihilator. Mike serves as a full time professor at Berklee, so it made perfect sense for his Signature Snare to be based on the ancient architectural phenomenon that is the Golden Ratio. This snare drum is a modern marvel!



MM1062
Size (Dia. X Depth) : 10" X 6.2"
Shell : 6 even ply Birch
Hoops : SuperHoop II (SH1006 / 1006S) w/OptiMount (OPTA-0665)
Lugs : STL-65
Rods : 6
Tension Rods : SST-5047 Stainless Steel Tension Rod
Strainer : SR-017
Snares : S-032N



Tico Torres
After decades of international success with Bon Jovi, Tico Torres worked with the Pearl design team and chose a cast aluminium shell to achieve a sound that has the warmth of a wood drum with the bite of a metal drum.





TR1465
Size (Dia. X Depth) : 14" X 6.5"
Shell : 3mm Cast Aluminium w / Reinforcement
Hoops : MasterCast (DCS1410 / DC1410S)
Lugs : FT-65
Rods : 10
Tension Rods : SST-5042 Stainless Steel Tension Rod
Strainer : SR-010
Snares : S-025



Morgan Rose
When rocking with his band Sevendust, Morgan needs his drum to be loud, powerful and full of attitude, so his mean 14"x5" Steel drum has all the projection to cut through huge speaker stacks and subwoofers. This snare features a nasty green metallic finish with glow-in-the-dark "Alien" graphic that can't be missed. The Morgan Rose Signature Snare Drum is a force to be reckoned with.



MR1450
Size (Dia. X Depth) : 14" X 5"
Shell : 1 mm Steel
Hoops : SuperHoop II (SH1410B / 1410S)
Lugs : CL-55
Rods : 10
Tension Rods : SST-5047 Stainless Steel Tension Rod
Strainer : SR-017
Snares : SN-1442I Ultra-Sound "I" Type, 42 Strands



Eric Singer
Eric has been rocking crowds around the world with mega band Kiss, and needed a drum that could match the intensity of their incredible live shows. His signature drum has an extra thick 10 ply Maple shell for impressive projection and outstanding power.





ES1465
Size (Dia. X Depth) : 14" X 6.5"
Shell : 10 Ply Maple
Air Vents : 3
Hoops : MasterCast (DCS1410 / DC1410S)
Lugs : CL-65
Rods : 10
Tension Rods : SST-5047 Stainless Steel Tension Rod
Strainer : SR-017
Snares : S-022N
Color : #160 Silver Sparkle



Joey Jordison
Joey Jordison has a reputation as one of the most influential, respected and successful drummers in the world today. Playing stadiums worldwide with Slipknot, Joey needed a snare drum with a higher pitch, monster bite, and this 13"x6.5" 1mm Steel shell Power Piccolo delivers the rage and power you'd expect from Joey.



JJ1365
Size (Dia. X Depth) : 13" X 6.5"
Shell : Steel/Black Finish
Hoops : SuperHoop II / Black Finish (SH1308B / 1308S)
Lugs : CL-65B
Rods : 8
Tension Rods : SST-5047 Stainless Steel Tension Rod
Strainer : SR-017B
Snares : SN-029N



Dennis Chambers
As one of the world's most respected International session musicians and clinicians, Dennis' signature snare drum has outstanding sound and tonal dynamics. This top specification drum includes a wide range of features to help you achieve the perfect sound.





DC1465
Size (Dia. X Depth) : 14" X 6.5"
Shell : 4 Ply Maple w/4 ply Maple Reinforcement Rings
Hoops : MasterCast (DCS1410 / DC1410S)
Lugs : CL-100
Rods : 10
Tension Rods : SST-5047 Stainless Steel Tension Rod
Strainer : 4-Way Adjustable / SR-020 on both sides
Snares : S-030N
Color : #136 Opal White



Virgil Donati
Virgil has pushed back the barriers of playing drums with his innovative use of the instrument, complex rhythms, creative phrasing and extreme speed, and naturally he has taken great care to design a unique snare drum. Using a 8 ply blended shell, rounded bearing edges and a totally flat snare bed, Virgil's signature snare drum is as state-of-the-art as his playing.



VG1450
Size (Dia. X Depth) : 14" X 5"
Shell : 8 Ply (Outer: 4 ply Maple / Inner: 4 Ply Birch)
Hoops : MasterCast (DC1410 / DC1410S)
Lugs : TB-50
Rods : 10
Tension Rods : SST-5042 Stainless Steel Tension Rod
Strainer : SR-017
Snares : SN-022N
Color : #188 Smoke Fade



Omar Hakim
Having played the drums for Sting, Madonna and David Bowie, to name but a few, Omar was looking for a unique sound in designing his signature snare drum. The 13" x 5" shell has a power piccolo sound while the Mahogany helps to produce the perfect blend of sonic power, projection and tonal color.





OH1350
Size (Dia. X Depth) : 13" X 5"
Shell : 6 Ply African Mahogany
Hoops : SuperHoop II (SH1308B / 1308S)
Lugs : CL-55
Rods : 8
Tension Rods : SST-5047 Stainless Steel Tension Rod
Strainer : SR-015
Snares : SN-029N
Color : #140 Natural Mahogany



Chad Smith
Explosive, versatile and funky...these words not only describe Chad's playing with the Red Hot Chili Peppers, but also describe the sound of his awesome signature snare drum. One of the best selling drums in Pearl's arsenal, the Chad Smith snare drum will help bring your groove to the next level.





CS1450
Size (Dia. X Depth) : 14" X 5"
Shell : Steel, Black Nickel Plated
Hoops : SuperHoop II (SH1410B / 1410S)
Lugs : CL-55
Rods : 10
Tension Rods : SST-5047 Stainless Steel Tension Rod
Strainer : SR-015
Snares : SN-022

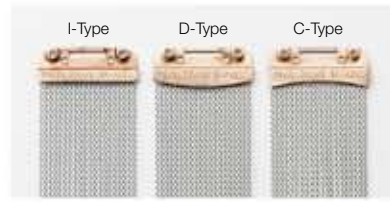

Ultra-Sound Snare Wires US.PAT.7202405

Pearl's UltraSound snares feature patented Graduated Tension wires with strategically positioned looser and tighter wires. The looser wires respond to the lightest touch while the tighter wires maintain head contact during the loudest playing. Combined, Graduated Tension wires extend the dynamic range of UltraSound snares far beyond that of standard snares. The SN-1420C features "C" shaped end plates with looser tension wires in the center for outstanding tracking and response, and is ideal for rock music and metal snare drums. The SN-1420D features "D" shaped end plates with tighter tension wires in the center for superb sensitivity, and is ideal for classical music and wood snare drums. The SN-1420I has even tension snare wires for those who want traditional snare dynamics, but with the benefits of the UltraSound's non-plated rust proof snare wires and ultra-thin, low mass 0.6mm Phosphor Bronze end plates for ultra quick response. The end plates have three mounting options: tunnels and holes for cord mounting, and slots for straps.



SR-1000 Glide-Lock Strainer US.PAT.7220905/7301087

Pearl's SR-1000 Glide-Lock strainer addresses two age-old strainer problems that have plagued drummers for years: the throw-off lever flipping off and the tension knob loosening while playing. The SR-1000's patented throw-off lever features a Positive Lock system that locks in the ON position and completely removes the possibility of the snares turning off no matter how hard you play. Using patented low-friction technology the lever has a smooth gliding action to raise and lower the snares with ultra quiet precision. The patent pending tension knob also locks and both the throw-off and butt plate can be removed from the shell with the snares attached to allow quick and easy bottom head changes.



THE FASTEST, SMOOTHEST, MOST VERSATILE PEDAL IN THE WORLD.

Heavenly Smooth.

The Direct Link's spherical bearings and a combination of custom settings create the smoothest pedal action possible.

Wickedly Fast.

Micro polished Ninja bearings along with self-aligning spherical bearings and the zero latency Z-link give the Demon Drive incredible speed.



Ninja Bearings
Designed for skateboarding these bearings feature micro-polished steel balls for amazing low friction.



Showing Longboard Setup

Tailor Made To Your Foot

With seemingly endless adjustments, the Demon Drive can be tuned to your specific taste.



DUO-DECK LONGBOARD
Converts quickly from shortboard to long board via 4 screws under footplate for your choice of feel.



BEATER STROKE ADJUSTMENT
A choice of 2 positions for a Finesse or Power. Simply loosen the clamshell to change position.



DIRECT LINK ADJUSTMENT
The 2 position direct link adjusts for a choice of light or heavy feel.



CLICK LOCK SPRING TENSION
The Click Lock prevents the tension knob from loosening. Simply flip up for adjustment.



ADJUSTABLE TRACTION PLATE
The Aluminum Traction Dots are fully adjustable to vary the amount of slip or grip for your playing.



FOOTBOARD HEIGHT ADJUSTMENT
Loosen and rotate to desired footboard height. Rotation is clearly indexed for ease of setup.



ZERO LATENCY U-JOINTS
Zero latency Z-Link U-joints prevent backlash and promote optimal feedback for incredible speed and control.



Z LINK DRIVE SHAFT
Adjustable machined Aluminum for perfect positioning and flex-free energy transference for precise feel.



CONTROL CORE BEATERS
The standard Control Core Felt and the optional wood beater feature anti-vibration elastomer core.



CARRY CASE
The Demondrive comes standard with a carry case to protect your pedal from the wear and tear of travel.



DOUBLE PEDAL COMPLETE (RIGHT-FOOTED) P-3002D
SHOWING SHORTBOARD SET-UP

DOUBLE PEDAL CONVERSION KIT (RIGHT-FOOTED) P-3001D
DOUBLE PEDAL CONVERSION KIT (RIGHT-FOOTED) P-3002DL

SINGLE PEDAL COMPLETE P-3000D
SHOWING SHORTBOARD SET-UP

PEDAL SETTING OPTIONS

Adjustments to the Direct Link, Beater Stroke and Footboard will customize the pedal creating a perfect fit for any playing style.

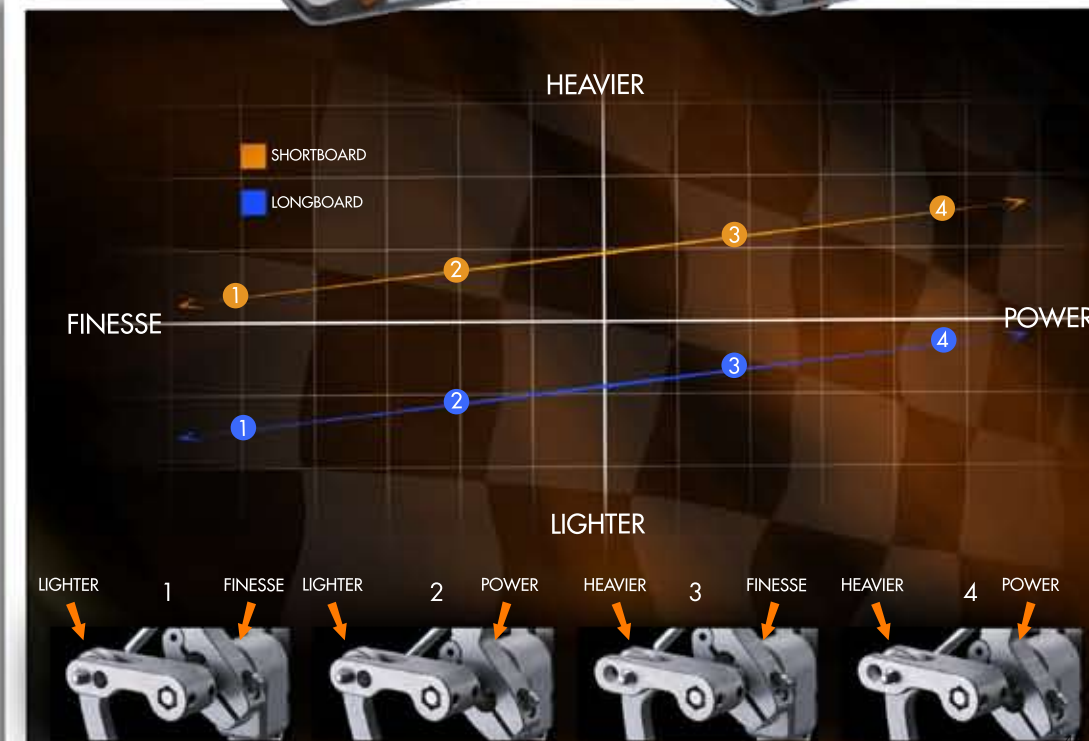

PEARL DRUM PEDALS

POWERSHIFTER ELIMINATOR DRUM PEDALS P-2000 SERIES

CHAIN DRIVE

Pearl's sprocket-less double chain drive provides super smooth action with powerful and precise feel. Since there are no teeth, the "grinding" noise common with most chain drive pedals is eliminated making the Eliminator perfect for studio work.



P-2000C

BELT DRIVE

Our Belt Drive provides a very comfortable, natural feel similar to a direct drive system. We use an extremely strong, highly durable drive belt, instead of a normal rubber strap, to provide maximum durability, strength, and stretch resistance.



P-2000B



DOUBLE PEDAL COMPLETE (RIGHT-FOOTED)
P-2002C

DOUBLE PEDAL CONVERSION KIT (RIGHT-FOOTED)
P-2001C

DOUBLE PEDAL COMPLETE (LEFT-FOOTED)
P-2002CL



DOUBLE PEDAL COMPLETE (RIGHT-FOOTED)
P-2002B

DOUBLE PEDAL CONVERSION KIT (RIGHT-FOOTED)
P-2001B

DOUBLE PEDAL COMPLETE (LEFT-FOOTED)
P-2002BL

PowerShifter ELIMINATOR

P-2000 SERIES



INTERCHANGEABLE CAM SYSTEM

US.PAT.6172291

Our exclusive Cam System provides six (included 4 + optional 2) interchangeable color coded cams allowing you to quickly change the power and feel of the pedal to suit your individual playing needs. Changing from cam to cam is as simple as pushing the release button and snapping another cam in place.

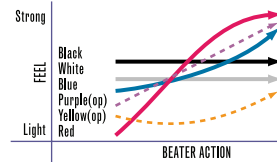

OPTION CAMS

- BLACK** LINEAR ACTION CAM
- WHITE** OVERSIZED LINEAR CAM
- BLUE** PROGRESSIVE CAM
- RED** RADICAL PROGRESSIVE CAM
- PURPLE** AGGRESSIVE ACTION CAM
- YELLOW** INVERSE ACTION CAM

This is Pearl's original "perfect circle" Cam design. It offers superior power and a very natural, perfectly balanced action and smooth feel.

The White Cam is a slightly over sized "perfect circle" Cam. It offers a very natural, smooth action, with great power and balance, with a slightly lighter pedal feel.

This is the very popular "off-center" axis type cam design. It offers a light feel in the beginning that accelerates with speed and power upon impact.

The Red Cam features an extreme "off-center" axis design. The action is similar to the Blue Cam but with a lighter feel at the beginning of the stroke.

The Purple cam provides aggressive acceleration for huge power and response, second only to the Red cam.

The Yellow cam provides a slight inverse action. When maximum power is required, this is the cam of choice.



POWERSHIFTER

US.PAT.5574237

Our revolutionary PowerShifter function provides 3 positions to fine tune the power and feel of the pedal. By moving the footboard forward or back you change the chain or belt drive angle, thus changing the leverage to create a light, normal or strong feel.



INDEPENDENT TRACTION GRIPS

Power Shifter Eliminator's Traction Plate footboard insert allows you to remove and reconfigure each individual traction grip to suit your exact playing requirements. From maximum grip to full slide, and every option in between, the choice is yours. The Traction Plate also reverses to focus the slide or grip surfaces to either the toe or heel of the pedal.

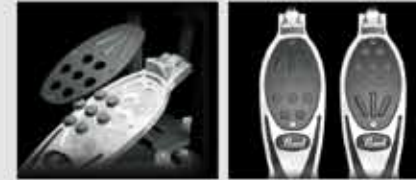

ZERO PLAY HINGE

Our stainless steel hinge is manufactured with incredibly precise tolerances to prevent play between the footboard and heel yet provides maximum freedom of motion for blazing speed. (US.PAT.7179978)

FOOTBOARD ANGLE ADJUSTMENT

Footboard angle is easily adjusted and completely independent from beater angle allowing you to further fine tune the feel and action of your pedal.



ROLLER CAM HOOP CLAMP

Our Roller Cam Hoop Clamp multiplies each turn of the adjustment knob to speed the process of attaching the pedal to the hoop. It fits an extremely wide range of hoop thicknesses and offers the smoothest, most secure grip possible. (US.PAT.5726370)

WIDE TENSION-RANGE SPRING

Our counter spring has been designed to perfectly complement the weight and balance of the footboard and beater assembly. It also offers a much wider range of adjustability allowing you to fine tune the pedal tension to suit your playing style.

UNI-PRESSURE SPRING CLAMP

Our Uni-Pressure Spring Clamp System grips a full 360 degrees and allows infinite beater angle adjustments. Featuring a unique Floating Spring Pendulum design that is perfectly centered on the clamp, this system offers full precision bearing movement for unmatched smoothness.

QUADBEATER

Our QuadBeater provides four different beater surfaces, each with its own distinct sound. You can choose from 2 hard plastic surfaces or 2 felt surfaces and either pinpoint or line contact with the head.

QUADBEATER

(US.PAT.5610351)



DUOBEAT

(US.PAT.5610351)



BEATER WEIGHT

BW-100 (US.PAT.7122730)

The BW-100 Beater Weight features a main body (10.4 gram) and two removable add-on weights: Black (7.2 grams) and Silver (5.8 grams) that can be added or subtracted to achieve perfect feel and power.

PEDAL STABILIZER

PS-85

POWERSHIFTER DRUM PEDALS P-900 SERIES

The P-900 is jam packed with high-end features such as a linear round cam, single chain drive, patented PowerShifter, infinitely adjustable beater angle, and PowerPlate.



P-900



DOUBLE PEDAL COMPLETE (RIGHT-FOOTED)
P-902

NEW



DRUM PEDALS P-120



PEARL DRUM PEDALS

MODEL	POWERSHIFTER ELIMINATOR P-2000 SERIES				P-900 SERIES		P-120
	P-2000C	P-2002C	P-2000B	P-2002B	P-900	P-902	P-120
DRIVE	Double Chain		Belt		Single Chain		Single Chain
CAM	Interchangeable Cam				Aluminum Die-Cast Wheel		Aluminum Die-Cast Wheel
POWERSHIFTER	•	•	•	•	•	•	---
FOOTBOARD	TractionPlate & TractionGrip						
FOOTBOARD ANGLE	3 Positions				---		---
BEATER	QUAD BEATER				DUO BEAT		DUO BEAT
BEATER ANGLE	Uni-Pressure Spring Clamp				Beater Angle Cam		Beater Angle Cam
SPRING ROLLER	Bearing				FrictionLess Roller		FrictionLess Roller
HOOP CLAMP	Roller Cam Hoop Clamp						

P-2000 SERIES come standard with Custom Carry bags



HI-HAT STANDS



POSILINK TWIN CAM DRIVE SYSTEM w/ INTERCHANGEABLE CAMS
(US.PAT.6399866)

Our exclusive PosiLink drive system features twin double chain driven cams one of which accepts your choice of 6 interchangeable cam profiles (4 included and 2 optional) so you can customize the response from mild to wild. If you want a traditional direct drive feel, use one of the two round cam profiles. But if you dare, try the four eccentric cam profiles with varying degrees of offset for accelerated feel that you can't get from any other hi-hat on the planet!

No other part of your kit takes the punishment that your Hi-hat takes. It has to be fast, responsive and strong to keep the groove moving. Pearl offers a wide range of Hi-hats to complement your playing style from our light-weight, easy to carry H-72W to our state-of-the-art Eliminator, that like our Eliminator pedals, features our patented interchangeable cam system for customized feel to allow the pedal to become an extension of yourself.



POWERSHIFTER

PowerShifter allows the player to quickly shift the footboard to one of three playing positions. This changes the angle of the pull chain which in turn changes the overall feel of the hi-hat reaction.

TRACTION PLATE FOOTBOARD

Like all Eliminators, the pedal has removable traction grip inserts that can be adjusted or removed to tailor the amount of grip or slip. The plate is even reversible for more choices.

VARISET FOOTBOARD ANGLE ADJUSTMENT

The VariSet cam is infinitely adjustable to allow micro-fine adjustment of the footboard angle for optimum comfort and speed. Footboard angle can be further adjusted by moving the chain to three positions on the pedal cam.

1. SUPERGRIP CLUTCH [SGC-300P] (PAT.PEND)

The H-2000 features our SuperGrip Clutch. This clutch system uses a larger surface area with 360 degrees of grip that provides vice like clamping force for super grip.

2. HI-HAT CUP (US.PAT.7078606)

Our patented seat cup features a hinged platform for outstanding stability and consistent hi-hat sound.

3. PRECISION SPRING TENSION DIAL



Our precision Spring Tension Dial features a positive click stop design for precise control over hi-hat tension.

4. SWIVELING LEGS

Our swivelling legs allow perfect placement by themselves or with multi-pedal set-ups. (*except H-72W)

5. CONVERTIBLE SPIKE / RUBBER TIPS (PAT.PEND)

The extra large non-slip rubber feet have a push button activated spike that pops out for non-slip grip on carpet or rubber surface. A second button returns it instantly to its recessed position.

6. NEW FOOTBOARD DOCKING STATION

The H-2000 now features a patent pending footboard attachment system and docking station for improved stability and security during transport. The footboard is attached via a tongue and groove-type locking system that holds the stand rigidly at a perfect 90 degree angle for maximum stability. The integrated docking station clamps the footboard safely and securely during transport for maximum protection of the chain and cam system.

7. STANDARD CLUTCH (CL-300)

Our CL-300 clutch used on H-1000 series hi-hats features our Triple-Lock gripper system for zero slippage.

8. FOOTBOARD ANGLE ADJUSTMENT

The H-1000's exclusive threaded foot board connector allows the footboard to be infinitely adjustable for maximum speed and comfort.

9. ROLLER PULLEY SYSTEM (US.PAT.5018426)

The roller system uses a pulley to provide incredible cymbal force with minimal pedal exertion.

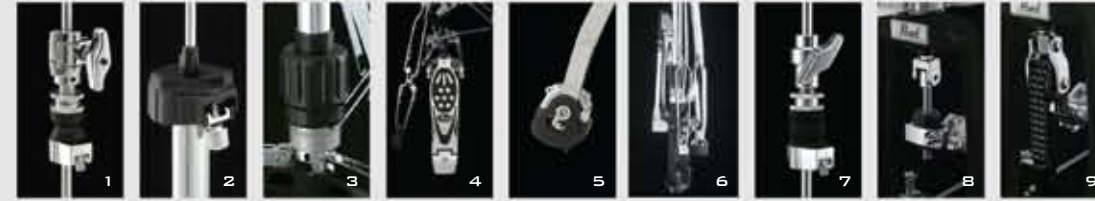

2000 series

1000 series



HI-HAT ACCESSORIES CLOSED HAT CLH-1000

The CLH-1000 facilitates the placement of closed hi-hats anywhere on your kit. It includes a boom arm, infinitely adjustable Uni-Lock tilter, pivot-action seat cup and ergonomic UltraGrip wing nuts/ wing bolts.



HI-HAT ATTACHMENT HA-100

The HA-100 positions your hi-hat next to your bass pedal in double bass set-ups for super quick transitions between pedals.



HI-HAT STANDS

MODEL	ELIMINATOR SERIES		1000 SERIES		900 SERIES	70 SERIES
	H-2000	RH-2000	H-1000	H-1000K	H-900	H-72W
DRIVE	PosiLink Twin Cam Drive Interchangeable Cams		Direct Pull	Roller Pulley System	Direct Pull	Direct Pull
POWERSHIFTER	•	•	---	---	---	---
FOOTBOARD	TractionPlate & TractionGrip		TractionPlate & TractionGrip			
FOOTBOARD ANGLE	VariSet Footboard Angle Adjustment		Footboard Angle Adjustment			
CLUTCH	SuperGrip Clutch w/ Lock Nut	Drop Clutch	Standard Clutch w/ Lock Nut		Standard Clutch	Standard Clutch
SPRING TENSION ADJUSTMENT	•	•	•	•	•	---
SWIVELING LEGS	•	•	•	•	•	---
LEG TIPS	Push Button Convertible (Spike / Rubber)	Reversible (Spike / Rubber)	Reversible (Spike / Rubber)		Rubber	Rubber





Our Snare Stands are available with a wide range of options and features. From our lightweight easy to carry S-70W for the local gig to our flagship S-2000, all Pearl snare stands will cradle your prized snares perfectly and dependably for years to come.

SNARE STANDS



SNARE STANDS

MODEL	S-2000	S-1000	S-1000D	S-900	S-70W
HEIGHT(mm)	450 - 630mm		360 - 540mm	460 - 650mm	435 - 650mm
SIZE	10" - 16"		12" - 14"	13", 14"	13", 14"
TILTER	GyroLock			Uni-Lock	Gear System
ARM TIPS	Suspension Rubber Tips			Rubber Tips	Rubber Tips
LEGS	SureStrut / Double Braced Legs			Double Braced Legs	Double Braced Legs
LEG TIPS	Push Button Convertible Rubber Tips		Rubber Tips	Rubber Tips	Rubber Tips



Hundreds of Snares,
One Snare Stand

ALL FIT SNARE STAND S-2000

ALL FIT SNARE ARMS

The all-fit snare arms found on our S-2000 allows individual adjustment of the snare arms to fit drums from 10" to 16". This unique feature also allows the offset placement of your drum for total positioning control. The patented (US.PAT.6710236) Air Suspension rubber tips securely cradle your prized snares without applying unnecessary pressure to the shell. This offers security for your snare without compromising resonance and sustain.

GYROLOCK TILTING SYSTEM

The GyroLock tilter allows complete tilt control over your snare angle. The Ultra-Grip wingnuts make adjustments quick and sure.

PUSH BUTTON CONVERTIBLE RUBBER TIP

The S-2000 features convertible rubber/spike tipped feet that allow your stand to adapt to any playing surface. A push of a button activates spike tips that provide maximum bite on carpeted surfaces. A second button returns them to their recessed position. (PAT.PEND)



TILTING SYSTEM

The S-900 features our Uni-Lock infinitely adjustable tilter for pinpoint drum placement.



SBA-1 SNARE BASKET ADAPTER

The SBA-1 attaches quickly to the tips of the S-800W snare stand to accept a broader range of snares including Sopranos and Effects Snares to 10". Rubber inserts prevent the snare from slipping. Sold in packs of 3.

DRUM THRONES

If you can't sit comfortably you can't play your best. That's why Pearl thrones, like our Roadster Series, feature ergonomic accents that promote good posture and comfort during extended playing. Innovative features such as the reversible backrest, and two-zone cushion on the D-2000BR throne and the shock absorber cushion on the D-1000SP that minimizes shock to your spine to fend off fatigue, are just some of the comfort features you'll find on Pearl thrones.



Our ergonomic seat provides two unique seating options. Firm padding with a smooth channel in the center can be used with the channel facing forward or backward to suit your personal preference. (D-2000BR / D-2000)

The quick release height adjustment clamp features a fine tuner for perfect height settings. (D-2000BR / D-2000 / D-1000 / D-1000S / D-1000C)

The built-in shock absorber minimizes shock to your spine to maximize comfort. (D-1000SP)

The spring tension is quickly and easily adjustable for your preferred level of comfort. (D-1000SP)

The height collar features vice-like clamping action for slip-proof dependability. (D-75)

DRUM THRONES

MODEL	D-2000BR	D-2000	D-1000	D-1000S	D-1000C	D-1000SP	D-900	D-80	D-75	D-70W
HEIGHT(mm)	490 - 650mm		470 - 630mm	425 - 580mm	470 - 630mm	500 - 660mm	460 - 660mm	500 - 660mm	430 - 680mm	430 - 650mm
SEAT	PVC			PVC	Velvet	PVC	PVC / Memory Foam	Saddle / PVC	PVC	
LEGS	SureStrut / 4-Double Braced Legs			SureStrut / 3-Double Braced Legs			SureStrut / 3-Double Braced Legs		3-Double Braced Legs	
	Back Support			Short Type		Build-in Shock Absorber				

CYMBAL STANDS

Pearl cymbal and boom stands are the choice of the working drummer. Solid and strong with thick chrome finishes that ensure a long life and dependable service, Pearl Advanced Hardware Systems stands are available with a wide range of options to fit your every need. From the studio to the stage, you can count on Pearl hardware.

WINGLOC (US.PAT. 6884015)

Our WingLoc quick release wing nut makes old fashioned wing nuts a bleak memory with its snap on, snap off ease of use. Whereas traditional wing nuts have to be manually unscrewed or screwed tighter, the WingLoc just slides onto a cymbal holder and snaps together to hold the cymbal firmly in a matter of seconds.



Our patented Reversible Seat Cup (US. PAT. 6940006) can be set to Float like a traditional seat cup or it can be reversed and Locked for 100% rattle-free performance for recording applications.

GYROLOCK & UNI-LOCK
GyroLock allows a full 360 degree range of motion for the fastest, easiest, and most precise setting of cymbals and toms. See it on our award-winning and revolutionary BC-2000 boom stand. Spin it. Lock it. Play it!
Uni-Lock tilters provide infinite positioning options and lock securely with a twist of our ergonomic UltraGrip wing bolts.

SETTING

The BC-2000 offers so many diverse mounting possibilities. With a built-in knurled post, it's perfect for adding cowbells or percussion effects. Add on some additional TL-2000 GyroLock Tilters and mount multiple cymbals on the same boom tilter.



DETACHABLE COUNTER WEIGHT

The detachable counterweight ensures perfect balance and stability.

DIE-CAST JOINT

Our die cast pipe joints provide unrelenting grip for solid and dependable positioning while the hidden nylon bushings inside the tubes prevent metal-to-metal contact for rattle free and quiet performance.

SURESTRUT & STOPLOCK

The BC-2000 also features our double strut legs to prevent lateral movement and positive stop memory locks for repeatable height settings.

OVERSIZED NON-SLIP RUBBER FEET

The over-sized non-slip rubber feet are the foundation of the BC-2000's stability. They provide sure footing and absorb unwanted overtones.

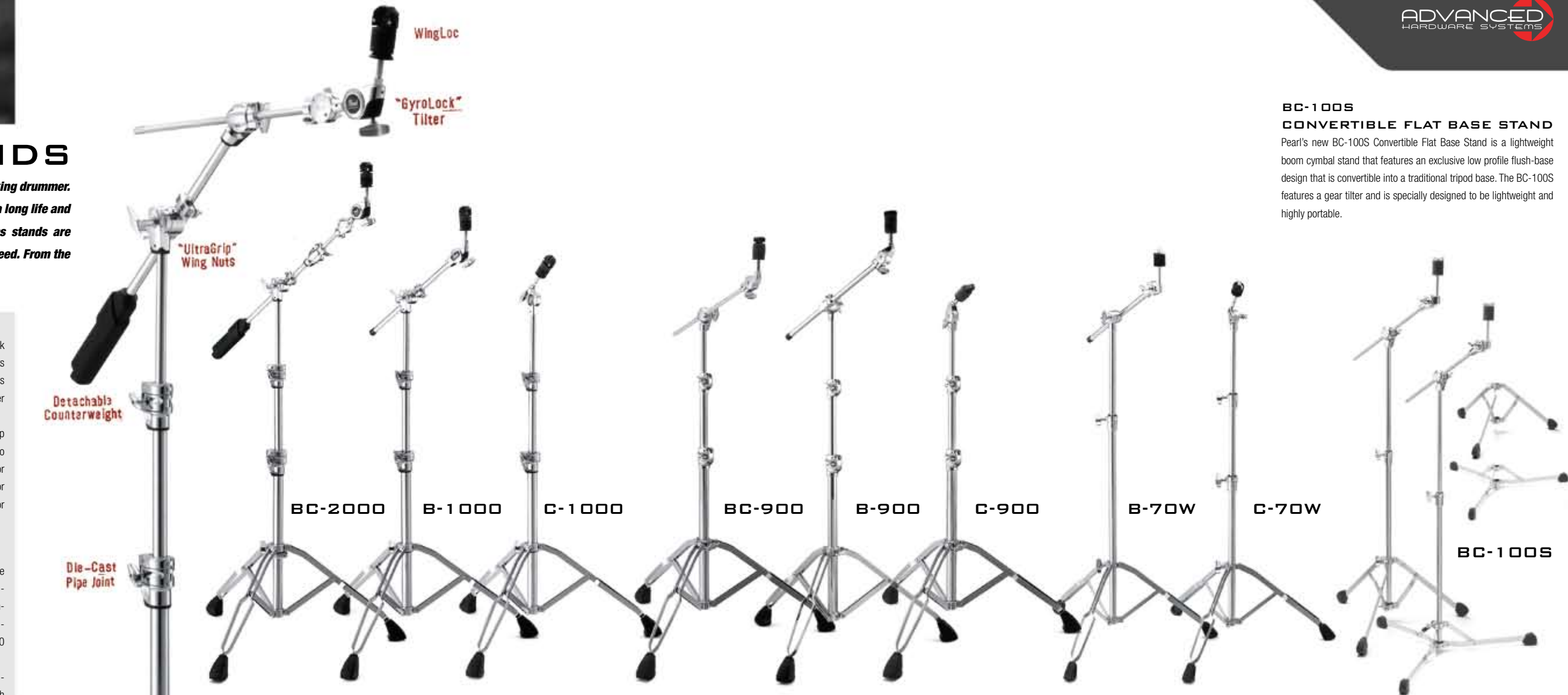

BC-100S CONVERTIBLE FLAT BASE STAND
Pearl's new BC-100S Convertible Flat Base Stand is a lightweight boom cymbal stand that features an exclusive low profile flush-base design that is convertible into a traditional tripod base. The BC-100S features a gear tilter and is specially designed to be lightweight and highly portable.

CYMBAL STANDS

	2000 SERIES			1000 SERIES			900 SERIES			70 SERIES		100 SERIES
MODEL	BC-2000	B-1000	C-1000	BC-900	B-900	C-900	B-70W	C-70W	BC-100S			
CYMBAL TILTER	WingLoc			Plastic Wing Nut			Wing Nut, Vinyl Tube, Felt		Wing Nut, Vinyl Tube, Felt			
	Reversible Cup Washer w/ O-Ring			Plastic Cymbal Cup			Steel Washer		Steel Washer			
PIPE JOINT	GyroLock			Uni-Lock			Gear System		Gear System			
	Die-cast Joint w/ Stop Lock			Die-cast Joint			Nylon Bushing Joint		Nylon Bushing Joint			
LEGS	SureStrut / Double Braced Legs			Double Braced Legs			Double Braced Legs		Single Braced Legs			
PIPES	28.6 / 22.2 / 15.9 mm			28.6 / 22.2 / 15.9 mm			22.2 / 19.1 / 15.9 mm		19.1/15.9 mm			

CYMBAL HOLDERS

MODEL	CH-2000	CH-2000S	CH-1000	CH-80	CH-70
DIAMETER	22.2mm			15.9 - 28.6mm	

CYMBAL STACKERS

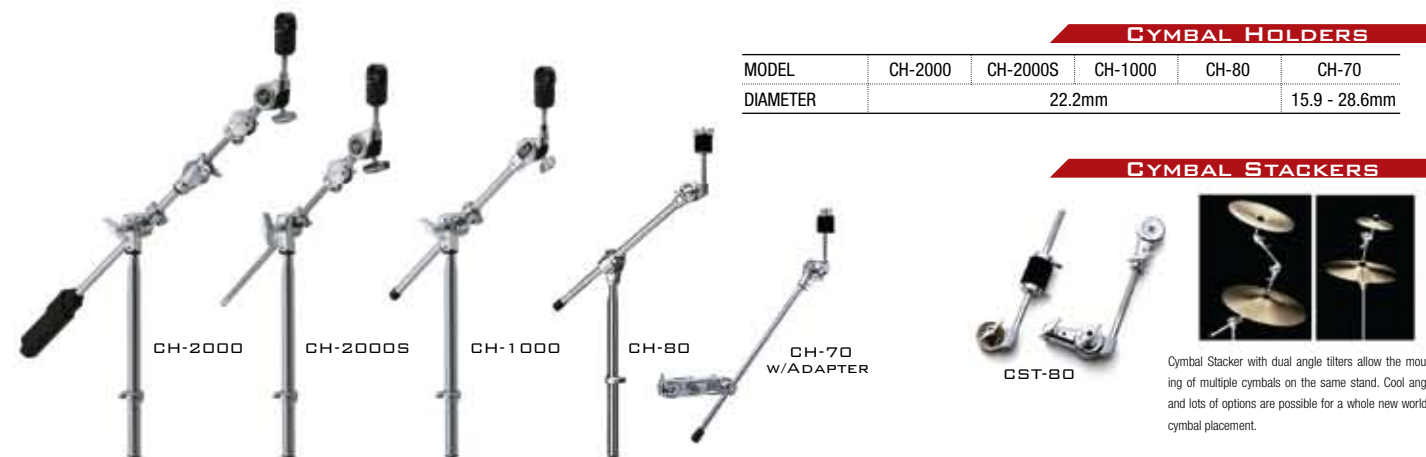

Cymbal Stacker with dual angle tilters allow the mounting of multiple cymbals on the same stand. Cool angles and lots of options are possible for a whole new world of cymbal placement.

Fits B-800W, C-800W, BC-800W, C-70W, B-70W, CH-80



DRUM RACKS

Pearl's **ICON Series** are the gold standard for drum racks. Its patented square aluminum tubing allows clamps to hold without turning or sliding for ultimate stability and each section is independently height adjustable. Our clamps feature high-strength die cast construction and hinged quick release jaws for fast set up and tear down.

ICON racks are available with straight or curved tubes in front and three-sided versions.

Expansion kits are also available with straight and curved tubes for customized set ups.

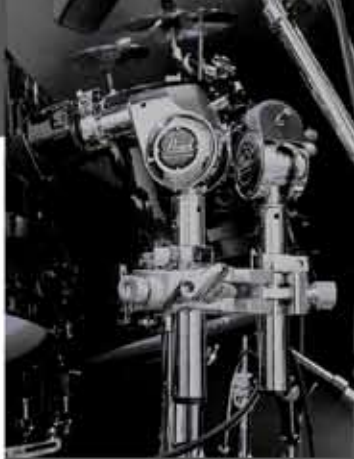

TOM STANDS TOM HOLDERS

Our Advanced Hardware Systems **TH-2000** and **TH-1000** Tom holders provide positioning capabilities never before available. Large non-slip rubber feet and No rattle tubes make our tom stands the studio kings.



ICON 3-SIDED RACK
DR-503
w/ PCX-100(4), PCL-100(2)

ICON FRONT RACK
DR-501
w/ PCX-100(2), PCL-100

ICON FRONT RACK
DR-501C
Curved Bar, w/ PCX-100(2), PCL-100



3-SIDED RACK
DR-80
(also available DR-008 Expansion Bar)

ICON EXPANSION BAR
DR-501E

ICON EXPANSION BAR
DR-501CE

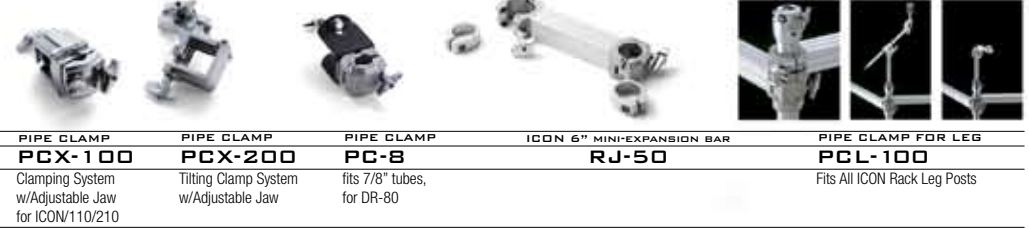

PIPE CLAMP
PCX-100
Clamping System w/Adjustable Jaw for ICON110/210

PIPE CLAMP
PCX-200
Tilting Clamp System w/Adjustable Jaw

PIPE CLAMP
PC-8
fits 7/8" tubes, for DR-80

ICON 6" MINI-EXPANSION BAR
RJ-50

PIPE CLAMP FOR LEG
PCL-100
Fits All ICON Rack Leg Posts



COMBINATION STANDS				DOUBLE TOM STANDS			
GYROLOCK	UNI-LOCK	UNI-LOCK	GEAR	GYROLOCK	UNI-LOCK	UNI-LOCK	GEAR
TC-2000	TC-1000	TC-900	TC-800W	T-2000	T-1000	T-900	T-800W
w/ TH-2000S, CH-2000S	w/ TH-1000S, CH-1000S	w/ TH-900S, CH-900S	w/ TH-88S, CH-80	w/ TH-2000S(2)	w/ TH-1000S(2)	w/ TH-900S(2)	w/ TH-88S(2)



TOM HOLDERS			
GYROLOCK	UNI-LOCK	UNI-LOCK	GEAR
2000 SERIES	1000 SERIES	900 SERIES	88 SERIES
TH-2000 TH-2000I TH-2000S	TH-1000 TH-1000I TH-1000S	TH-900 TH-900S	TH-88 TH-88I TH-88S

ADAPTERS



AX-20	AX-25	AX-25L	AX-28	AX-38
2 Clamps fits 5/8"~1-1/8"	2 Revolving Clamps fits 1/2"~1-1/8"	2 Revolving Clamps fits 1/2"~1-1/8"	In-Line & Revolving Clamps fits 5/8"~1-1/8" & 1/2"~1-1/8"	fits 3/8" ~ 1-1/4" 3 Adjustable Clamps



UNIVERSAL CLAMP
UX-80 13" Long Tube
UX-80S 4" Long Tube



HEIGHT EXTENDERS
TX-100 13" Long Tube

COWBELL HOLDER
CA-100 Hoop Mounted, Adjustable L-Arm
75H Hoop Mounted



COWBELL HOLDER
75X 7/8" Dia Tube
PPS-30 3/8" Post
PPS-37 Multi-Angle "L" Arm



GYROLOCK & UNI-LOCK

The TH-2000 utilizes our GyroLock tilter with infinite 360 degree range of movement. The TH-1000 and TH-900 feature our dependable Uni-Lock tilter with 180 degree infinitely adjustable range of motion.

Pearl Percussion

Pearl Percussion Artists

 Alfredo Ortiz The Beastie Boys	 Andres Bermudez A.B. Tribal Drums	 Andy Farag Umphrey's McGee	 Anthony Carrillo Eddie Palmieri	 Archie Pena Shakira	 Aaron Draper Common	 Bobby Allende Ocho Y Mas
 Camilo Moreno B-Side Players	 Brett Baker Jay-Z	 Camilo Quinones B-Side Players	 Carlito Soto Willie Colon	 Carmelo Torres Del Castillo	 Cesar Carvajal	 Cesar Espinoza Orquesta Tabaco Y Ron
 Chino Bolanos Independent	 Count M'Buto The Derek Trucks	 Curtis Rodriguez Marc Anthony	 Daniel Antonetti New York Independent	 Dante Roberson Independent	 Dimas Sanchez Rico Monaco, Iba A Se	 Domingo "Tito" Gutierrez Sonora Poncena
 Ernesto Diaz Berklee Faculty	 Ettienne Fuentes Chayanne	 Fausto Cuevas Stevie Wonder	 Francisco Aguabella L.A. Independent	 Future Man Bela Fleck & The Flecktones	 Gilad ON 3	 Hector "Pocho" Neciousup Miami Independent
 Horacio Hernandez	 Jessie Caraballo Marc Anthony	 Jesus Diaz San Francisco	 Jimmy DeGrasso F5	 Jose Gregorio Nestor Torres	 Jose Rosa Miami Independent	 Johnny Blas
 Jose Claussell Eddie Palmieri	 Juan Pablo Romero Oscar de Leon	 Lalo Davila MTSU	 Luis Cuenca B-Side Players	 Marc Quiñones Allman Brothers Band	 Marco "Ito" Arguinizoni New York	 Mario Monaco New York Independent
 Mark Lamson Brazilian Master	 Michael Cartellone Lynyrd Skynyrd	 Michael Butler Akon	 Michael Duffy Joan Sebastian, Ozomatli	 Michito Sanchez	 Nino Sanchez Jessica Simpson	 O.G. Slightly Stoopid
 Olbin Burgos Gloria Estefan	 Omar Hakim	 Omar Ledezma L.A. Independent	 Papo Pepin New York Legend	 Papo Rodriguez Johnny Polanco	 Pete Korpela The Lion King	 Rafael Pereira Sasha Lisnichuk
 Ramses Araya Ruben Blades	 Ray Colon New York	 Ravi Jakhota Ravi Drums	 Raymond Carrasquillo Puerto Rico	 Richard Bravo Los Temerarios	 Richie Flores New York	 Robert Vilera Miami
 Rolando Morales-Matos The Lion King	 Sammy Figueroa Jazz & R&B Legend	 Sammy Garcia Puerto Rico	 Stanley Randolph Stevie Wonder	 Valerie Dae-Naranjo The Lion King, SNL	 Will Kennedy WK Krew	
 Glen Caruba	 Bart Fermie	 Dawne Adams Pet Shop Boys	 Eddie Conard Independent	 Gijs van Straaken Wouter Hamel, Sensual	 Lucas van Merwijk	 Nils Fisher
 Pablo Escayola James Last Orchestra						

Signature Series

Marc Quiñones Signature Timbales Set

ETE-1415MQ

Designed in conjunction with one of today's premier percussionists, Marc's timbale set consists of standard 14 and 15 inch drums fitted with Remo Clear Ambassador heads, and packed with a ton of innovative features that only Pearl can deliver. The Polished Steel Shells have two inverse beads that not only add strength, but also produce a cutting "cascara" sound (side of the shell) not hindered normally by outward facing beads. To further the "cascara" striking area, this set features a 5-Lug Design that is proportioned perfectly for leaving maximum shell space and less lug interference. Tuning is easier than any other timbales on the market, utilizing a top tuning lug design with included socket wrench. This exclusive Pearl design, cuts the time changing heads in half - No more nuts and washers falling on the floor! The cowbell post features a Sympathetic Sound Dampening sleeve so your cowbells and blocks do not ring through the stand, and the whole unit can be mounted in seconds using a one wing-nut design. A double braced tilting stand, and our top-selling PBL-30 Clave Block are included.



Q-Popper Timbale Snare w/ Mount

ETE-1205MQ

The Marc Quiñones Signature Q-Popper 12"x5" Timbale Snare is perfect for accenting a traditional Salsa group, as well as an auxiliary add-on to your drum set. With the snares on it "pops" with all the characteristics of a small metal snare drum, yet throw the snares off (via the SR-018 style strainer) and you have an awesome timbale to spark Caribbean flavor to your sound. The Q-Popper matches Marc's Signature steel timbales and comes standard with the NEW PPS-36 Angled Post Adaptor to conveniently mount it off any cymbal or hi-hat stand.



Marc Quiñones
Signature
Timbales Set
ETE-1415MQ

Richie Flores Signature Oak Congas and Bongos

PCW-110DXRF 11" Quinto | PCW-117DXRF 11.75" Conga | PCW-125DXRF 12.5" Tumbá
PBW-300DXRF 7 & 9" Bongos

Why settle for one color when you can have solids, sparkles and fades all in one set of congas and bongos! With Richie Flores Signature drums you can have it all! Richie's exclusive "vertical" fade Lunar Eclipse finish transitions from dazzling Silver to rich Midnight Blue dusted in stellar sparkles as you turn the drums. Fade your congas from left to right, right to left, all Silver Sparkle or all Midnight Blue Sparkle...the color possibilities are limitless! The bongos feature an extra set of holes to allow the shells to be reversed to match the congas. Thai Oak shells with Contour Crown Rims, brilliant chrome plated hardware, and our exclusive Self-Aligning Washer System (S.A.W.S.) for effortless tuning round out the features of these beautiful instruments.



Richie Flores Signature
Oak Congas and Bongos
#527 Lunar Eclipse

Bobby Allende Signature Fiberglass Congas and Bongos

PCF-110DXBA 11" Quinto | PCF-117DXBA 11.75" Conga | PCF-125DXBA 12.5" Tumbá
PBF-300DXBA 7 & 8.5" Bongos

Bobby demands the best, so he designed his Signature Fiberglass Congas and Bongos to exceed all existing standards, right down to the smallest detail. For example, the seams are invisible, thus giving his congas the look of natural wood. The congas are 28" tall to fit the traditional seated player, and the wider base adds projection and stability. A new rim design on both congas and bongos adds extra comfort while complimenting the fitted Remo Fibreskyn3 heads.

Bobby Allende Signature Fiberglass Congas and Bongos
NEW COLOR! #619 Solar Sparkle
#620 Café Con Leche



Jesus Diaz Signature Cuban Cajons

PCJ-110JD Segundo Cajon (11")
PCJ-120JD Tumbador Cajon (12")
PCJ-100JD Quinto Cajon (10")



Pearl's Folkloric Cuban Cajons are inspired by master Afro-Cuban percussionist, Jesus Diaz, and feature the classic Cuban wedge shape for deep resonating bass tones and cutting slaps. Available in 10", 11", and 12" sizes and pitched in thirds, they can be played in traditional settings or used as an alternative to congas. The newest addition to the line is the Tri-Tone Cajon. The 11" wooden playing surface is designed like a traditional Cuban cajon, but with the inclusion of our exclusive PSA-10 Snare Rake allows you the option of adding a snare sound. Turn the drum on its side, and you have the option of playing traditional bata rhythms with a cool yet convincing alternative to an ltolele since the bottom is also a playing surface. The Tri-Tone Cajon is so versatile, you will find applications for it in all genres of music.



PCJ-1123
Tri-Tone Cajon
NEW!

Cajon Stand
PCJ-100S 10"
PCJ-110S 11"
PCJ-120S 12"

Horacio "El Negro" Hernandez Signature Cowbells

Designed by Horacio Hernandez, this series of five cowbells are pitched in accordance to "El Negro's" strictest of standards. Intended for Drumkit and Percussion players, the unique features include two playing surfaces: flat on one side, and curved on the other. The tone is the same, but the distinctive bi-shaped design will give the player the option of striking the bell directly facing in or the side (like a timbale player). The two-position cowbell bracket will ensure that the wing-nuts will not get in the way when stacking multiple bells and blocks on one post. This makes it much easier to adjust the bells from virtually any position. Another exclusive feature is found on the smallest bell, the HH1 Bella two rubber gaskets separate the mount from the body of the bell offering maximum tone and resonance that is usually "choked" and "dry" with other cowbells of this size. Finished in beautifully plated copper, this professional line of cowbells sound and look like no other on the market.



HH-1 BELLA Hi-pitch Cha-Cha bell
HH-2 ClaBELL Foot-Clave bell
HH-3 ChaBELLa Low-pitch Cha-Cha bell
HH-4 IsaBELL Mamba bell on BD
HH-5 MaryBELL Timbale bell

PPS-20 Cowbell Footpedal Bracket with HH-2 and P-2000C
The PPS-20 features squared dimples post for maximum support without the "L" rod slipping. Eyebolts/wings and knurled pegs which are reversible; rubber tip or spike.

Congas

Pearl has congas to meet the needs of every player from seasoned professionals to beginners. Our Elite Series offers the highest quality heads with polished Contour Crowns and a choice of shell materials: 100% aged Oak or seamless Fiberglass. Our Primero Pro line features professional-quality construction at an affordable price and a choice of 100% Oak or Fiber-glass construction. Primero features outstanding Pearl quality and a choice of 100% Oak or Fiberglass construction at value pricing.

Bongos

Our Bongos offer professional features and authentic styling in a choice of shell materials to perfectly match your Conga Set. Elite Series Bongos feature Contour Crowns and polished steel hardware with a choice of 4 finishes for Oak and 2 finishes for Fiberglass. Primero Pro offers professional features with a choice of 4 finishes for Oak and 3 finishes for Fiberglass. Primero offers maximum affordability with black powder-coated hardware and a choice of Natural finish Oak and 3 Fiberglass finishes.



Elite Mahogany Congas
 PCW-110MX 11" Quint
 PCW-117MX 11-3/4" Conga
 PCW-125MX 12-1/2" Tumba
 #530 Natural Mahogany



Primero Pro Oak Conga Set
 PWC-202DX 10" / 11" #521 Midnight Fade
 (shown with PC-100DX, PC-110DX stands)

Primero Pro Fiberglass Conga Set
 PFC-202DX 10 / 11" w/o Stand and PFC-120DX 12" w/o Stand
 #626 Gold Marble

Primero Pro Fiberglass Bongos
 PFB-100DX 7" and 8.5"
 #626 Gold Marble

Elite Mahogany Series
 Pearl's Elite Mahogany Series of congas and bongos feature our exclusive "Spline-Joint" technology that uses splines to mechanically secure the staves both horizontally and vertically to greatly increase the surface area of the joints for strength that others can't match. The shells feature an inner layer of hard Para Wood for improved volume and increased mid and low frequencies and an outer layer of Mahogany for incredible looks. Another feature is our Contour Crown Rims with a lower profile for greater comfort on your hands and our exclusive Self-Aligning Washer System (S.A.W.S.) that isolate the tension hooks from the inner walls of the lugs for greater tuning ease. The Pearl Elite Mahogany, where state-of-the-art construction creates state-of-the-art sound.

Congas & Bongos Available Finishes

Elite Series			Primero Pro Series				Primero Series			
Mahogany			Oak	Fiberglass	Fiberglass	Oak	Fiberglass	Oak	Fiberglass	
#530 Natural Mahogany	#531 Cosmic Sparkle	#511 Natural	#521 Midnight Fade	#523 Carbon Vapor	#621 Wine Red Marble	#622 Black Marble	#626 Gold Marble	#511 Natural	#602 Bistre Black	#610 Deco Blue



Travel Conga
 PTC-1100 11" Travel Conga
 PTC-1175 11.75" Travel Conga
 PTC-1250 12.5" Travel Conga
 PC-1100TC Stand for 11" w/Carrying Bag
 PC-1175TC Stand for 11.75" w/Carrying Bag
 PC-1250TC Stand for 12.5" w/Carrying Bag
 PPS-50TC Stand Bridge

Travel Cajon
 PTCJ-1265 NEW! 12" Travel Cajon

Travel Conga

The Travel Congas are available in three standard head diameters: 11", 11.75" and 12.5" yet only 3.5" deep. They feature wood shells and stave construction (identical to our full-size congas) and the Remo FiberSkyn 3 synthetic tone head for outstanding tone that is unaffected by changes in temperature or humidity. Five precision Allen bolts provide accurate and easy tuning via the included foam-handle Allen wrench. Pearl's Travel Conga stand is designed specifically with two things in mind: rock solid stability, and lightening fast set-ups and pack-ups. The stand includes a "Y" bracket that attaches to the bottom of your Travel Conga and mounts to the stand centered directly under the drum for maximum stability. The Travel Conga stand comes with a carrying bag that includes a pocket for the optional PPS-50TC Bridge that connects two stands together to minimize creeping while performing.

Travel Cajon

The newest compliment to the M.I.P.A. Award-Winning Travel Conga is Pearl's new Travel Cajon. This portable Cajon is packed with "full size" features and sound that, like the Travel Conga, will fool most ears into believing it is the real thing. The 12" wood playing surface resonates the 6-1/2" shell with a solid bottom and sound port that is large enough to manually adjust our exclusive Snare Rake system. A simple twist of the thumbscrew gives you the option of snares "on" or "off". The Travel Cajon can be mounted comfortably on your lap (secured by the included Velcro strap), or on a snare stand in a seated or standing position. Finished in Gloss Black Pearl's Travel Cajon is portable, versatile, and contagiously fun to play.

Practice Conga PPC-120 Practice Conga w/Video
 The perfect learning tool for the on-the-go percussion student or the seasoned pro warming up backstage. It features a Velcro strap to secure it to your lap and includes a video hosted by Glen Caruba to teach you the basics of hand percussion. Practice anywhere, anytime.

Primero Bongo Attachment PB-700BHS
 If you use a double conga stand, the PB-700BHS is the simplest way to add bongos to your conga setup. The PB-700BHS features full height and "tilt" adjustment, fits virtually any brand of bongos, and attaches securely to the mounting brackets on our PC-200W and PC-950TW double conga stands.

Snare Drum Hand Adapter PSA-10
 The Hand Drum Snare Adapter, PSA-10 (or Snare Rake) is great for adding spice to your Djembe and Conga sound. Fits to most hand drums in the market today, it adds a snare sound effect so easily and quickly.

Conga Shell Saver NEW! CSR-60
 Pearl's new Conga Shell Savers are specially designed to prevent the nicks and scratches that can occur during play. Sold in packs of 6, the Conga Shell Savers quickly and easily slide onto the existing conga lug, and are an inexpensive way to protect your conga instruments.

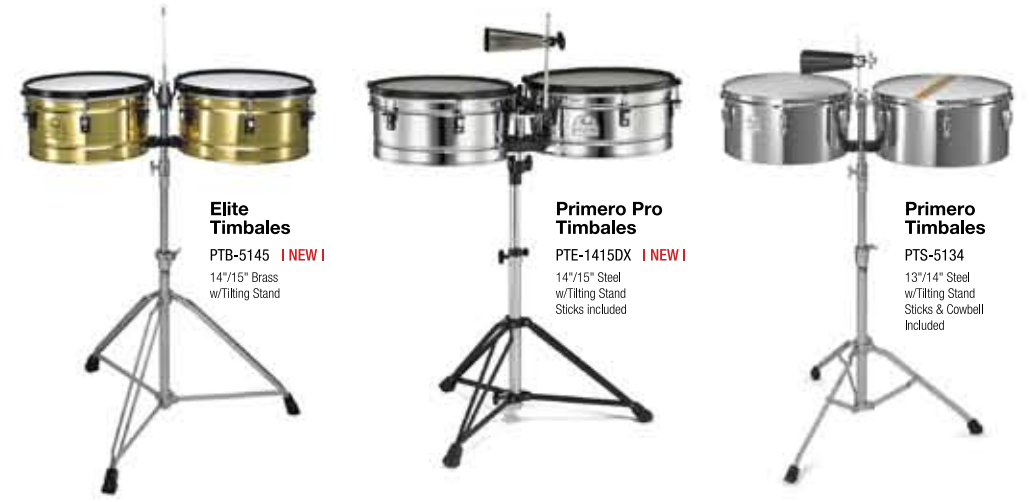

Elite Timbales
 PTB-5145 NEW!
 14"/15" Brass w/Tilting Stand

Primero Pro Timbales
 PTE-1415DX NEW!
 14"/15" Steel w/Tilting Stand
 Sticks included

Primero Timbales
 PTS-5134
 13"/14" Steel w/Tilting Stand
 Sticks & Cowbell Included



Primero 13" Steel Timbale
 PTE-1336 w/ PPS-36 Mount

Primero Flat Timbs
 PTB-3131 Flat Timbale w/I.S.S. (Brass)
 PTE-3131 Flat Timbale w/I.S.S. (Steel)

Elite Timbale I.S.S. Plate
 PSP-1345 An I.S.S. mounting bracket (less BT-3) for attaching Elite Timbales to racks and tom Arms.



Elite Oak Djembe
 PJW-340 12-1/2" #511 Natural

Elite Fiberglass Djembe
 PJF-350 14" PJF-320 12-1/2" #602 Bistre Black

Primero Fiberglass Djembe
 PJF-310 9-1/2" #610 Deco Blue

Fiberglass Rope Tuned Djembe
 PJF-310R NEW!
 10" #629 Carubinga

Djembe Stand
 PC-800S NEW!
 Djembe Stand



DjemBass
 PJBs-350 NEW!
 If you want extreme low-end, and a head-turning alternative to a standard bass drum, look no further than to Pearl's DjemBass. Convert our most popular PJF-350 Fiberglass Djembe into a compact kick drum with the DjemBass accessory pack. To reduce the attack and add greater "lows" we have included a cloth cap that stretches around the head. For greater low-end, slip the included neoprene disc inside which give you two sound options. Your pedal (not included) attaches via an I.S.S. type clamp to the Djembe's stand mounting plate.

bass drum, look no further than to Pearl's DjemBass. Convert our most popular PJF-350 Fiberglass Djembe into a compact kick drum with the DjemBass accessory pack. To reduce the attack and add greater "lows" we have included a cloth cap that stretches around the head. For greater low-end, slip the included neoprene disc inside which give you two sound options. Your pedal (not included) attaches via an I.S.S. type clamp to the Djembe's stand mounting plate.

Elite Batas
 #526 Crimson Sunrise



PBA-60 Itotele

PBA70 Iya

PBA-50 Oconcolo

Batas

Pearl Percussion Bata drums are now available in Crimson Sunrise, the same beautiful finish featured on our Folkloric Percussion congas and bongos. Additionally, the hardware is now finished in Polished Steel and matches the hardware on our other tunable hand drums. These sacred ceremonial instruments have a thicker Enu (large) head for a deep, rich tone.



Jingle Cajon
 PCJ-629 NEW!
 #629 Carubinga



Elite Box Cajon
 PBC-503 Matte Wine Red w/Natural Front Plate

Primero Box Cajon
 PBC-507 #507 Gypsy Brown

Timbales

Pearl's new Primero Pro Steel timbales are a budget conscious timbale set packed with professional features. The heavy-duty double braced tilting stand securely supports the 14 & 15-inch steel shells that are 7 inches deep for added projection and greater cascara surface area. The cowbell mount is based off our PT-900 Timbale stand making set-up and teardown possibly in seconds. Tuning wrench and sticks are included.

Djembes

Djembes are a traditional African instrument that offer a wide variety of sounds and are perfect for drum circles. The Professional Elite Series is available in Oak (12.5" diameter) and Fiberglass (12.5" and 14" diameter). All feature our Contour Crowns for comfortable playing and authentic Goat skin heads for deep lows and crisps highs. Our Primero Djembe is perfect for the beginning percussionist with its durable Fiberglass construction and compact 9.5" size. The 10" X 19" Fiberglass Rope Tuned Djembe features an exclusive exotic wood finish called Carubinga. The goatskin head offers a real feel and warmer tone that delivers an astonishingly large sound for a smaller djembe. Our NEW PC-800S Djembe stand is fully height adjustable and with the tilting feature, your Djembe is locked into place at the perfect angle. The single braced stand and Fiberglass djembe body makes this package amazingly lightweight.

Cajons

In conjunction with L.A. session percussionist Pete Korpela, Pearl's new Jingle Cajon offers four different sound possibilities in one package. The fiberglass body adds superior strength, and the super responsive snare system offers sensitivity unmatched by other brands. Simply twist open the Brazilian Platinella-style jingles and a new world of sonic options open up, as you instantly sound like two percussionists playing simultaneously. Open up the Stainless Steel tambourine jingles for a whole other jingle option, or combine the two to sound like an entire percussion section. Beautifully finished in our exclusive Carubinga exotic wood finish, Pearl's Jingle Cajon will surely open your eyes and ears to an arsenal of sound never thought possible from a single Cajon. The Primero Box Cajon is constructed from Asiatic Pine and is finished in Gypsy Brown matte lacquer, while our Elite Box Cajon is constructed of a harder Para Wood stained in Amaranth Red. Both feature fully adjustable snares that can be played "on" for Spanish Flamenco-style or "off" for Peruvian-style playing. The front plate is designed for maximum bass and super-sensitive snare response.

Bala Bells



BCM-3 Bala Cha-Cha Bell
BCM-5 Bala Fusion Bell
BCM-7 Bala Mambo Bell

BCH-10 Hand-Held Campana Bell

Bala Cowbells



BCM-20 King Bala Rock Cowbell w/Power Flange

BCM-9 King Bala Timbale Cowbell

BCH-11 Bala Hand-Held Campana (Hi-Pitched)

Primero Cowbells



PCB-6 6" Bell

PCB-4 4" Bell

Cowbells

Pearl cowbells are available in a broad array of sizes and shapes to add diversity and flavor to your kit sound; and nothing completes that Salsa sound like a quality cowbell. If you're looking for power and clarity, look no further than our Bala Cowbells with their distinctive mirror polished, seamless design. Available in 7 different mountable sizes and 2 handheld models, there's a Bala Cowbell that is right for you. Primero Cowbells are available in 2 sizes: 4" and 6". Each offers great value and tone, superb volume and sturdy construction.



ECB-23 Mounted Agogo



ECB-22 Hand-held Agogo



PCB-1030 10" Bell w/PPS-30



PTA-30 Tri-Agogo



PTB-30 Tri-Bells



PDC-10 Dual Cowbell Beater



PDC-50 Phenolic Cowbell Beater

Concert Percussion

Pearl is proud to offer Concert Percussion instruments that are attractively priced for school ensembles, yet engineered with the professional percussionist in mind. Pearl's High-Density Steel Concert Triangles, PET-100 (10"), PET-80 (8"), and PET-60 (6"), offer beautiful clarity with no unwanted overtones. Triangle accessories include the PTC-10 basic triangle clip and the revolutionary PTC-300 Trio Triangle Holder that can accommodate up to three triangles ranging from 6" to 10". Our staggered Double Row 10" Concert Tambourine (PETM-20) have thin stainless steel jingles in a hardwood frame and natural goat skin head. Our concert woodblocks (PCWB-10, PCWB-20, PCWB-30) are made of blended hardwoods and feature a raised spine in the center for easy striking with a mallet or stick. Our Stix-Free Triangle holder has a brass beater underneath two curved felt pads which strike the mounted triangle horizontally enabling you to play intricate syncopated patterns, and is fully adjustable to hold 6" to 10" triangles.



PETM-20 Elite Concert Tambourine



PET-100 PET-80 PET-60 Elite Triangles



PTC-300 Trio Triangle Holder PTC-10 Triangle Clip

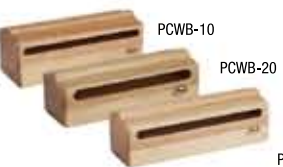

PCWB-10 PCWB-20 PCWB-30 Concert Wood Block



PPS-12T Stix-Free Triangle Holder

Taiko

All of Pearl's Taiko are made from staved oak which are beautifully finished in a matte natural stain and produces the rich warmth of wood without the expensive price tag of a traditional carved shell. The insides of the shells are shaped using a method called "Hado-Carving" with special reinforcement rings which are placed to break up the unwanted overtones producing a balanced sonic reflection within the drums. But the sound starts on the outside, with premium cow hide exclusively chosen for Pearl Taiko drums. Pearl's Bachi are from a domestic hardwood in Thailand known as Acacia and offered in three different diameters to suit the size of both the player and Taiko. You will want to protect your investment of these beautifully crafted instruments, so Pearl offers soft padded carrying cases for the larger Miya Taiko.



WOT-12 Miya Taiko 1S/2-Sun
WOT-15 Miya Taiko 1S/5-Sun
WOT-16 Miya Taiko 1S/6-Sun
WOT-18 Miya Taiko 1S/8-Sun
WHT-12 Hira Taiko 1S/2-Sun
WHT-14 Hira Taiko 1S/4-Sun
WST-20BL Shime Taiko w/Tension Lugs
WOT-120S Stand for WOT-12
WOT-15160S Stand for WOT-15/16
WOT-180S Stand for WOT-18



BAT-30A BAT-20A BAT-10A

More chaos than the law will allow, all available from Pearl! Pearl's Anarchy products include our popular spike-riddled Anarchy Cowbell, the Anarchy Block, and the new Anarchy Crasher which easily cuts through the loudest musical situations. If you're looking to add some attitude to your kit, look no further than the Anarchy Percussion instruments from Pearl.

Anarchy Cowbell
PCB-20

Anarchy Block
PBL-100

Anarchy Crasher
PAR-100 **NEW!**

Hand Percussion

PCL-10 Fiber Claves

PMG-20 Metal Guiro

PNG-20 Natural Gourd Guiro

PBL-10 High (Neon Green)
PBL-20 Medium (Neon Yellow)
PBL-30 Low (Neon Orange)
Clave Block w/Holder

CBS-100 Gatling Cabasa

PWR-40 Shakelets

We offer an ever expanding line of effects from around the world to add flavor and color to your sound with bold improvements over the traditional. The Synthetic Fiber Claves produce a cutting clave sound, and are virtually indestructible. The Metal Guiro provides a unique metal sound and is perfect for Merengue rhythms. The Natural Gourd Guiro has two playing sides for different sound effects. Coated with fiberglass gel in the interior, it has projection and volume, and the rubber ring gives strength to the shell, making this Guiro the last you'll ever purchase. Our Clave Blocks are neon color-coded synthetic blocks designed with our Chamber Density Variation Technology. This allows consistent shaping of each block, while varying each block's pitch by a third. Our Gatling Cabasa enables you to play tight rhythmic patterns by a turn of the rotator arm. The Shakelets feature Pearl's exclusive Brazilian-style platinellas, called "Ganzinellas". With Shakelets on the wrist endless possibilities are created. Clap your hands, shake them in the air or play them holding a drumstick. They are just plain fun. We have two new tambourines available called the Ultra Grip Tambourine with Jingle Control. The ski-pole, like ergonomic handle, is positioned near the tambourine's center of gravity for comfortable and effortless playing, and the Jingle Control Discs allow the jingles to be selectively muted to control the volume of your tambourine and complement your playing style. Like our popular PTM-10GH (Brass Jingle) and PTM-10SH (Stainless Steel Jingle) Tambourines each Ultra Grip Tambourine is equipped with Pearl's QuickMount holder that allows the tambourine to go from mounted to hand-held with a flick of your wrist. The new 36 Bar Aluminum Chromatic windchimes features self-dampening parallel swinging chimes for controlled chime sound. A soft roll-up carrying case is included that doubles as a towel that can be draped over a (horizontal) music stand to act as a trap table. The case includes a storage compartment for the optional PWH-20 Windchime Holder.

PTM-50BHR (Brass)
PTM-50SHR (Steel)
Ultra Grip Tambourine

PTM-10GH Tambourine w/Brass Jingles

PTM-10SH Steel Jingle Tambourine w/Stainless Steel Jingles

PTH-10B (Brass) PTH-10S (Steel) Headless Wood Tambourines

PTB-10 TomBourine

PFM-20 Beaded Maracas

PGA-20 Basket Ganzas (9" x 4")

PGA-30 (Short) Hex Ganzas

PEC-1 Egg Carton

PJH-10SH Hi Hat Jingle Ring

PJC-10SH Jingle Clamp

PWCH-3620A 36 Bar Aluminum Chromatic Case included
Wind Chimes

PTG-20 Tang-Tang

PAB-100 Low PAB-50 Medium PAB-20 High Ash Tone Block

PSC-30 Spirit Chimes w/Holder & Mallet

Brazilian Percussion

Authentic Brazilian Sound

Pearl's line of Brazilian Percussion brings modern refinements and Pearl quality to the traditional Samba musician. Our Repinique line with 10" and 12" Aluminum shells feature etched heads, shoulder strap, and low rims for superior playing comfort. Our super lightweight Cuica features an 8" Goat skin head and comes equipped with a carrying strap and a specially designed sponge. Two models of Pandeiros and a Pandanza with multi function effects and a traditional Tamborim round out the new line. All are offered in the traditional Brazilian colors of bright Blue, Yellow and Green for dynamic looks that will surely get you noticed where ever you play.

The lightweight wood shell Surdos allow for hours of comfortable play when worn over the shoulder with the provided strap. They are available in 18" x 22" and 22" x 22" sizes (diameter x depth) and include two-ply tunable heads with an outer ply of synthetic leather for accentuated low-end frequencies. Our patent-pending Leg/Bass Drum Adaptor Kit (PBS30BD) allows your Surdo to be played vertically like a floor tom or horizontally with a pedal like a bass drum. Pearl's new Caixa features a 12" x 4" wood shell, drum key tunable textured heads, and SR-018 style throw-off. It can be played traditionally around the shoulder with the provided strap, or attached to a stand as an auxiliary snare to your drum kit.



Surdo 18" PBS-1822
Surdo 22" PBS-2222
Legs & BD Adapter Kit for Surdo PBS-30
Surdo Mallet PBSM-20 **NEW!**
Caixa 12" PBCX-1204



Pandeiro 10" PBP-510 (5 sets platinellas & goatskin head) w/ bag
Pandeiro 12" PBP-612 (6 sets platinellas & plastic head) w/ bag
Pandanza PDZ-510 w/ agogo bell
Tamborim PBT-60
Tamborim Stick PBT-70S **NEW!**
Repinique 10" PBR-10 (w/ Strap)
Repinique 12" PBR-12 (w/ Strap)
Cuica PBC-80



Folkloric Percussion

This line of congas and bongos features a traditional look with modern innovation. Thicker South American style natural skins and a fiberglass gel coat on the interior seals provide the sound desired by today's players, and that of the classic Cuban sound. The Cata is a bamboo instrument played with sticks. Our Bamboo Claves produce a dry, "airy" tone that is lower in pitch than our "Chin-Chan" Hardwood Claves. The Achere is a single shaker with a handle used for time-keeping, while the Guataca, with scalloped edges for scraping, gives great metallic effects.



Folkloric Elite Bongos
 PWB-300FC (7" and 8.5")
Folkloric Elite Congas
 PCW-125FC Tumbador (12-1/2")
 PCW-110FC Quinto (11")
 PCW-117FC Segundo (11-3/4")



Shekers
 PSK-50FC (Uno)
 PSK-70FC (Caja)
 PSK-60FC (Segundo)



Claves PCL-10FCB (Bamboo), PCL-10FCW (Wood)
Cata w/Holder PCA-14FC
Achere PAC-10FC
Guataca PGT-10FC

Sheker Holder PPS-45

Percussion Stands and Brackets

The PC-3000TW stand from Pearl is the lightest and most compact double conga stand on the market today. It holds full size professional congas as securely as most stands double its weight and mass. Set-up in seconds because there are no wingnuts needed to mount your congas. The base of the drums rest on adjustable stabilizer legs and gravity does the rest! With an included carrying bag the PC-3000TW stand has all the features you can ask for in a double conga stand: sturdy, lightweight, and extremely portable. The PC-2000 Conga Kick Stand is a one-size-fits-all stand packed full of user-friendly features. Designed to accommodate the standing percussionist, the PC-2000 features extendable legs and a contemporary frame designed to perfectly unite two, three, or four stands together.



Quick Release Double Conga Stand PC-3000TW **NEW!**



PC-2000 Conga Kick Stand
 PC-900 All-Fit Conga Stand
 PB-900W All-Fit Tiltng Bongo Stand
 PB-700 Lightweight Bongo Stand

Trap Table & Rack

Our popular PTT-1824 Trap Table can now be easily converted into a two-level folding rack without drilling or modifications by simply adding Pearl's new PTR-1824 Add-On Rack. The PTR-1824 installs in seconds using clamps and folds flush with the table for easy pack-up. A unique clamping system allows the included (4) straight and (4) angled 3/8" knurled posts to clamp anywhere onto horizontal or vertical areas of the rack. Also included is a retractable three-legged stabilizer bar for optimum stability.



Trap Table Single Post Adapter PTR-1824RC3 (For PTT-1824, PTT-1212)



Trap Table PTT-1824 (18 X 24")
Trap Table Rack PTR-1824 + PTR-1824
Trap Table PTT-1212 (12 X 12")

Percussion Cases

Pearl's new padded carrying cases include features like ergonomic carrying straps, rubber protective bottoms, top-mounted carrying handles, tuning wrench pouches, and heavy duty double zippers. The PPB100 is made from heavy weight nylon and will fit all Conga sizes.



PSC-125CG 12-1/2" Conga Bag
 PSC-110CG 10" Conga Bag
 PSC-117CG 11-3/4" Conga Bag
 PSC-BB Bongo Bag
 PSC-1118CJ Cuban Cajon Case
 PSC-1213CJ Box Cajon Case
 PSC-2000 Conga Kick Stand Case
 PSC-140DJ 14" Djembe Bag
 PSC-125DJ 12-1/2" Djembe Bag

Holder and Accessories

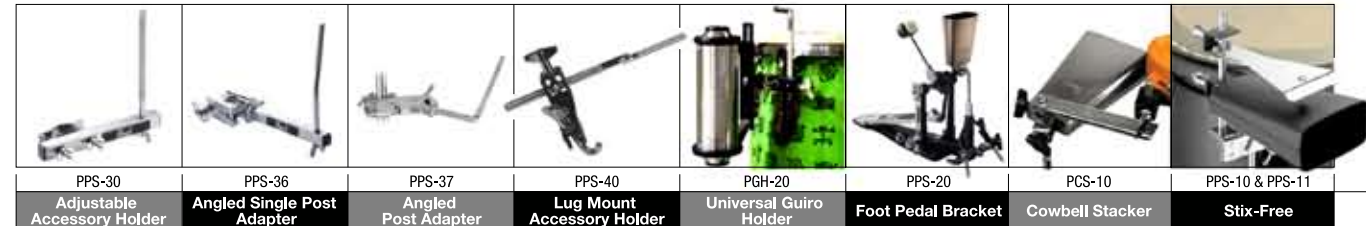

PPS-30 Adjustable Accessory Holder
 PPS-36 Angled Single Post Adapter
 PPS-37 Angled Post Adapter
 PPS-40 Lug Mount Accessory Holder
 PGH-20 Universal Guiro Holder
 PPS-20 Foot Pedal Bracket
 PCS-10 Cowbell Stacker
 PPS-10 & PPS-11 Stix-Free

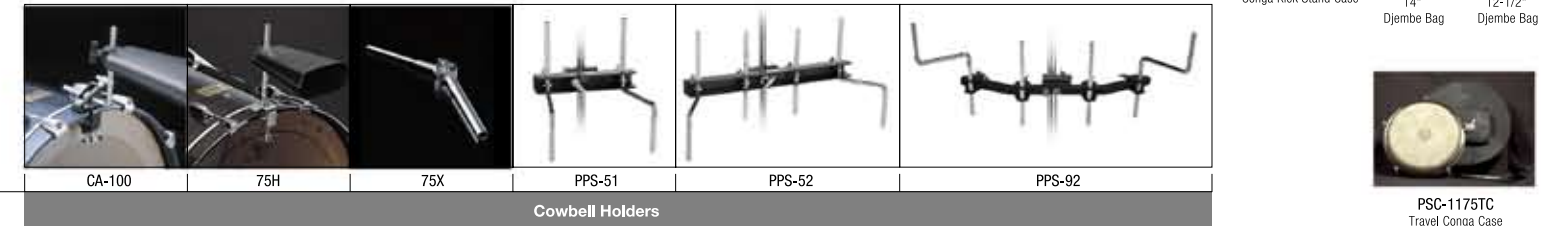

CA-100
 75H
 75X
 PPS-51
 PPS-52
 PPS-92
Cowbell Holders
 PSC-1175TC Travel Conga Case



OptiMount

Our OptiMount Suspension System attaches to the tom's tension rods and floats on rubber cushions, providing the ultimate in stability while allowing the drum to resonate fully without restriction. With OptiMount, the mounting hardware is completely removed from the drum shell, providing a drastic improvement in resonance and sustain.



- OPTA-0708/C** for drums 7"-8" deep, 6"-16" diameter, Light Weight Aluminum
- OPTA-0910/C** for drums 9"-10" deep, 6"-16" diameter, Light Weight Aluminum
- OPTA-1112/C** for drums 11"-12" deep, 6"-16" diameter, Light Weight Aluminum
- OPTA-1314/C** for drums 13"-14" deep, 6"-16" diameter, Light Weight Aluminum
- OPTA-1516/C** for drums 15"-16" deep, 6"-16" diameter, Light Weight Aluminum

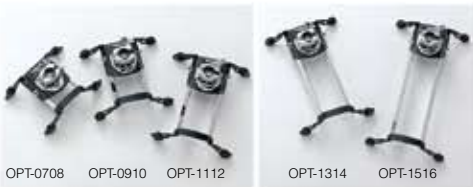

- OPT-0708/C** for drums 7"-8" deep, 8"-16" diameter, UltraGrip Wingnut
- OPT-0910/C** for drums 9"-10" deep, 8"-16" diameter, UltraGrip Wingnut
- OPT-1112/C** for drums 11"-12" deep, 8"-16" diameter, UltraGrip Wingnut
- OPT-1314/C** for drums 13"-14" deep, 8"-16" diameter, UltraGrip Wingnut
- OPT-1516/C** for drums 15"-16" deep, 8"-16" diameter, UltraGrip Wingnut

I.S.S.

Our standard I.S.S. mounts also remove all mounting hardware from the shell and clamp to the rim providing the quickest, easiest mounting system available today. (US.PAT. 5544561)



- | fits | Model # | Description |
|---------|--------------------|---------------------------------------|
| 8"-10" | IS-0810N/C | 1.6mm Steel Hoop, UltraGrip Wingnut |
| | ISS-0810 | Vision, UltraGrip Wingnut |
| | IS-0810SL/C | 2.3mm Superhoop II, UltraGrip Wingnut |
| 12"-16" | IS-1216N/C | 1.6mm Steel Hoop, UltraGrip Wingnut |
| | ISS-1216 | Vision, UltraGrip Wingnut |
| | IS-1216SL/C | 2.3mm Superhoop II, UltraGrip Wingnut |

Die Cast Hoops

MasterCast are the finest die cast hoops available and feature the perfect blend of thickness and mass to improve the depth, clarity, and focus of toms and snare drums.



Model #	Diameter	# of Tension
DC-0805	8"	5
DC-1006	10"	6
DC-1206	12"	6
DC-1306	13"	6
DC-1408	14"	8
DC-1408S	14"	8 Snare Side
DC-1410	14"	10
DC-1410S	14"	10 Snare Side
DC-1410SG	14"	10 Snare Side w/Guard
DC-1508	15"	8
DC-1608	16"	8
DC-1808	18"	8

Super Hoop II

SuperHoop II hoops are precision formed from heavy-duty 2.3mm steel, triple-flanged and engraved with the SuperHoop II logo.



Model #	Diameter	# of Tension
SH-0604	6"	4
SH-0805	8"	5
SH-1006	10"	6
SH-1006S	10"	6 Snare Side
SH-1206	12"	6
SH-1208	12"	8
SH-1208S	12"	8 Snare Side
SH-1306	13"	6
SH-1408	14"	8
SH-1408S	14"	8 Snare Side
SH-1410B	14"	10
SH-1410S	14"	10 Snare Side
SH-1410SG	14"	10 Snare Side w/Guard
SH-1508	15"	8
SH-1608	16"	8
SH-1808	18"	8

Steel Hoops

Model #	Diameter	# of Tension
RIM-0604	6"	4
RIM-0804	8"	4
RIM-0805	8"	5
RIM-1006	10"	6
RIM-1006SL	10"	6 Snare Side
RIM-1206	12"	6
RIM-1206SL	12"	6 Snare Side
RIM-1208B	12"	8
RIM-1208S	12"	8 Snare Side
RIM-1306	13"	6
RIM-1308B	13"	8
RIM-1308S	13"	8 Snare Side
RIM-1406	14"	6
RIM-1408B	14"	8
RIM-1408S	14"	8 Snare Side
RIM-1410B	14"	10
RIM-1410S	14"	10 Snare Side
RIM-1410SG	14"	10 Snare Side w/Guard
RIM-1508	15"	8
RIM-1606	16"	6
RIM-1608	16"	8

Bass Drum Hoop Protectors



- HPP-2** Metal Hoop Protector for Wood BD Hoops
- NP-01** Hoop Protector for Metal BD Hoops
- NP-347/2** Non-Slip Hoop Protector for Wood BD Hoops (pair)

Ultra-Sound Snares

Pearl's Ultra-Sound snares feature patented Graduated Tension wires for extended dynamic range from ultra soft to ultra loud. Ultra-thin, low mass end plates assure ultra quick response. The end plates feature three mounting options: tunnels or holes for cord mounting and slots for straps. US.PAT.7202405



- SN-1320C** 20 strands for 13", C-type, w/straps & cords
- SN-1320D** 20 strands for 13", D-type, w/straps & cords
- SN-1320I** 20 strands for 13", I-type, w/straps & cords
- SN-1420C** 20 strands for 14", C-type, w/straps & cords
- SN-1420D** 20 strands for 14", D-type, w/straps & cords
- SN-1420I** 20 strands for 14", I-type, w/straps & cords



- SN-1442C** 42 strands for 14", C-type, w/straps & cords
- SN-1442D** 42 strands for 14", D-type, w/straps & cords
- SN-1442I** 42 strands for 14", I-type, w/straps & cords

Replacement Snares



- S-022N** 20 Strand for 14" w/Cords
- S-022NU** 20 Strand for 14" w/Cords, Uncoated
- S-022NG** 20 Strand for 14" w/Cords, Gold Plated
- S-022** 20 Strand for 14" w/Straps
- S-025** 20 Strand for 14" long, w/Straps
- S-029N** 20 Strand for 13" w/Cords
- S-030N** 24 Strand for 14" w/Cords
- S-031N** 20 Strand for 12" w/Cords
- S-032N** 12 Strand for 10" w/Cords
- S-033N** 12 Strand for 12" w/Cords
- S-040** 15 Strand for 14" w/Cords, Steel Cable, Thinner Gauge
- S-041** 15 Strand for 14" w/Cords, Bronze Cable, Thicker Gauge
- SPS-18/6** Plastic Strap (6/pkg)
- SNC-40/6** Snare Cord (6/pkg)